



OWNER'S MANUAL

SLIDER

EW50

5WK-F8199-E0

Welcome to the Yamaha world of motorcycling!

As the owner of the EW50, you are benefiting from Yamaha's vast experience and newest technology regarding the design and manufacture of high-quality products, which have earned Yamaha a reputation for dependability.

Please take the time to read this manual thoroughly, so as to enjoy all advantages of your EW50. The owner's manual does not only instruct you in how to operate, inspect and maintain your scooter, but also in how to safeguard yourself and others from trouble and injury.

In addition, the many tips given in this manual will help keep your scooter in the best possible condition. If you have any further questions, do not hesitate to contact your Yamaha dealer.

The Yamaha team wishes you many safe and pleasant rides. So, remember to put safety first!

IMPORTANT MANUAL INFORMATION

Particularly important information is distinguished in this manual by the following notations:



The Safety Alert Symbol means **ATTENTION! BECOME ALERT! YOUR SAFETY IS INVOLVED!**



Failure to follow **WARNING** instructions could result in severe injury or death to the scooter operator, a bystander, or a person inspecting or repairing the scooter.



A **CAUTION** indicates special precautions that must be taken to avoid damage to the scooter.

NOTE :

A NOTE provides key information to make procedures easier or clearer.

NOTE : _____

- This manual should be considered a permanent part of this scooter and should remain with it even if the scooter is subsequently sold.
 - Yamaha continually seeks advancements in product design and quality. Therefore, while this manual contains the most current product information available at the time of printing, there may be minor discrepancies between your scooter and this manual. If you have any questions concerning this manual, please consult your Yamaha dealer.
-

IMPORTANT MANUAL INFORMATION

EW000002

⚠ WARNING

PLEASE READ THIS MANUAL CAREFULLY AND COMPLETELY BEFORE OPERATING THIS SCOOTER.

EAUM0023

EW50
OWNER'S MANUAL
© 2003 by MBK INDUSTRIE
1st Edition, January 2003
All rights reserved
Any reprinting or unauthorized use
without the written permission of
Yamaha INDUSTRIE
is expressly prohibited.
Printed in France.

TABLE OF CONTENTS

1	GIVE SAFETY THE RIGHT OF WAY	1
2	DESCRIPTION	2
3	INSTRUMENT AND CONTROL FUNCTIONS	3
4	PRE-OPERATION CHECKS	4
5	OPERATION AND IMPORTANT RIDING POINTS	5
6	PERIODIC MAINTENANCE AND MINOR REPAIR	6
7	SCOOTER CARE AND STORAGE	7
8	SPECIFICATIONS	8
9	CONSUMER INFORMATION	9



GIVE SAFETY THE RIGHT OF WAY

GIVE SAFETY THE RIGHT OF WAY 1-1



GIVE SAFETY THE RIGHT OF WAY

Scooters are fascinating vehicles, which can give you an unsurpassed feeling of power and freedom. However, they also impose certain limits, which you must accept; even the best scooter does not ignore the laws of physics.

Regular care and maintenance are essential for preserving value and operating condition of your scooter. Moreover, what is true for the scooter is also true for the rider: good performance depends on being in good shape. Riding under the influence of medication, drugs and alcohol is, of course, out of the question. Scooter riders — more than car drivers — must always be at their mental and physical best. Under the influence of even small amounts of alcohol, there is a tendency to take dangerous risks.

Protective clothing is as essential for the scooter rider as seat belts are for car drivers and passengers. Always wear a complete scooter suit (whether made of leather or tear-resistant synthetic materials with protectors), sturdy boots, scooter gloves and a properly fitting helmet. Optimum protective wear, however, should not encourage carelessness. Although full-coverage helmets and suits, in particular, create an illusion of total safety and protection, motorcyclists will always be vulnerable. Riders who lack critical self-control run the risk of going too fast and are apt to take chances. This is even more dangerous in wet weather. The good motorcyclist rides safely, predictably and defensively — avoiding all dangers, including those caused by others.

Enjoy your ride!



Further safe-riding points

- Be sure to signal clearly when making turns.
- Braking can be extremely difficult on a wet road. Avoid hard braking, because the scooter could slide. Apply the brakes slowly when stopping on a wet surface.
- Slow down as you approach a corner or turn. Once you have completed a turn, accelerate slowly.
- Be careful when passing parked cars. A driver might not see you and open a door in your path.
- Railroad crossings, streetcar rails, iron plates on road construction sites, and manhole covers become extremely slippery when wet. Slow down and cross them with caution. Keep the scooter upright, otherwise it could slide out from under you.
- The brake pads could get wet when you wash the scooter. After washing the scooter, check the brakes before riding.
- Always wear a helmet, gloves, trousers (tapered around the cuff and ankle so they do not flap), and a bright colored jacket.
- Do not carry too much luggage on the scooter. An overloaded scooter is unstable.

DESCRIPTION

Left view 2-1
Right view 2-2

DESCRIPTION

Left view

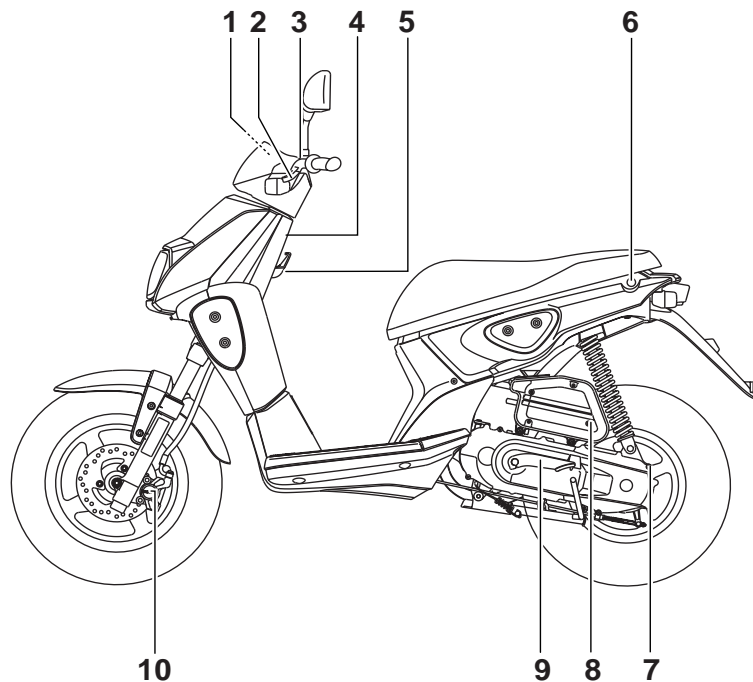

- | | | | |
|--------------------------------|------------|--------------------------------------|-------------|
| 1. Speedometer unit | (page 3-3) | 6. Seat lock | (page 3-8) |
| 2. Rear brake lever | (page 3-5) | 7. Final transmission oil filler cap | (page 6-6) |
| 3. Left handlebar switches | (page 3-4) | 8. Air filter element | (page 6-7) |
| 4. Main switch / steering lock | (page 3-1) | 9. Kickstarter | (page 3-8) |
| 5. Luggage hook | (page 3-8) | 10. Front brake pads | (page 6-12) |

Right view

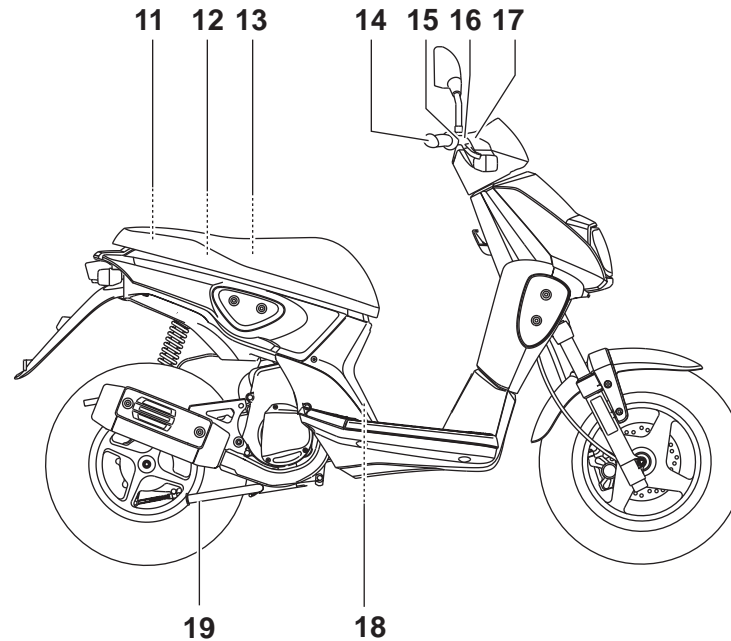

- 11. Fuel tank cap
- 12. Oil tank cap
- 13. Anti-theft device housing
- 14. Throttle grip
- 15. Front brake lever

- (Page 3-5)
- (Page 3-5)
- (Page 3-9)
- (Page 6-8)
- (Page 3-4)

- 16. Right handlebar switches
- 17. Front brake fluid reservoir
- 18. Battery (fuse)
- 19. Centerstand

- (Page 3-4)
- (Page 6-13)
- (Page 6-17 — 6-19)
- (Page 6-15)

INSTRUMENT AND CONTROL FUNCTIONS

Main switch / steering lock	3-1
Indicator and warning lights	3-2
Speedometer unit	3-3
Fuel gauge	3-3
Handlebar switches	3-4
Front brake lever	3-4
Rear brake lever	3-5
Fuel and 2-stroke engine oil tank caps	3-5
Fuel	3-6
2-stroke engine oil	3-7
Catalytic converter	3-7
Starter (choke) lever	3-7
Kickstarter	3-8
Seat	3-8
Luggage hook	3-8
Anti-theft device housing	3-9

INSTRUMENT AND CONTROL FUNCTIONS

3

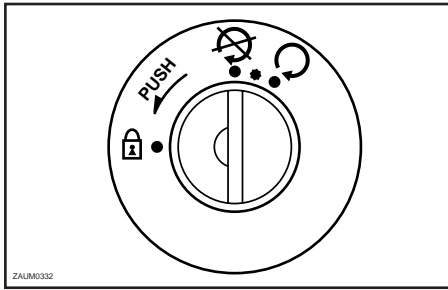

EAU00029

Main switch/steering lock

The main switch/steering lock controls the ignition and lighting systems, and is used to lock the steering. The various positions are described below.

EAU04384

ON “”

All electrical circuits are supplied with power, the taillight and meter lighting come on, and the engine can be started. The key cannot be removed.

NOTE :

The headlight comes on as soon as the engine is started.

EAU00038

OFF “”

All electrical systems are off. The key can be removed.

EAU04470

*



The 2-stroke engine oil level warning light should come on. See page 3-2 for an explanation of the engine oil level warning light.

EAUM0074

LOCK “”

The steering is locked, and all electrical systems are off. The key can be removed.

To lock the steering





1. Turn the handlebars all the way to the left.
2. Push the key in from the “” position, release it, and then turn it to “”.
3. Remove the key.

To unlock the steering

Insert the key and turn it to “”.

EW000016

⚠ WARNING

Never turn the key to “” or “” while the scooter is moving, otherwise the electrical systems will be switched off, which may result in loss of control or an accident. Make sure that the scooter is stopped before turning the key to “” or “”.

NOTE :

Remove the key from the main switch when the scooter will be left unattended.

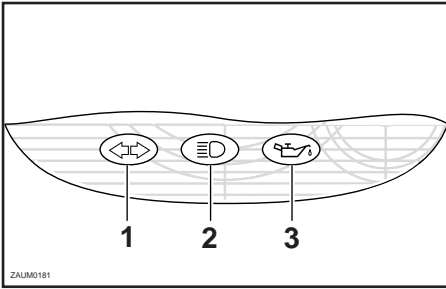

1. Turn signal indicator light “↔”
2. High beam indicator light “☞”
3. Oil level warning light “🏍️⬇️”

EAU03034

Indicator and warning lights

EAU00063

High beam indicator light “☞”

This indicator light comes on when the high beam of the headlight is switched on.

EAU00057

Turn signal indicator light “↔”

This indicator light flashes when the turn signal switch is pushed to the left or right.

EAU02958

Oil level warning light “🏍️⬇️”

This warning light comes on when the key is in the “✳️” position or when the oil level in the 2-stroke engine oil tank is low during operation. If the warning light comes on during operation, stop immediately and fill the oil tank with Yamalube 2 or equivalent 2-stroke engine oil of either JASO grade "FC" or ISO grades "EG-C" or "EG-D". The warning light should go off after the 2-stroke engine oil tank has been refilled.

NOTE :

If the warning light does not come on when the key is in the “✳️” position or does not go off after the 2-stroke engine oil tank has been refilled, have a Yamaha dealer check the electrical circuit.

EC000000

CAUTION:

Do not operate the scooter until you know that the engine oil level is sufficient.

INSTRUMENT AND CONTROL FUNCTIONS

3

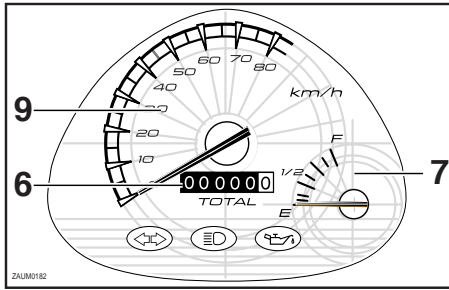

1. Speedometer
2. Odometer
3. Fuel gauge

EAU00098

Speedometer unit

The speedometer unit is equipped with a speedometer and an odometer. The speedometer shows riding speed. The odometer shows the total distance traveled.

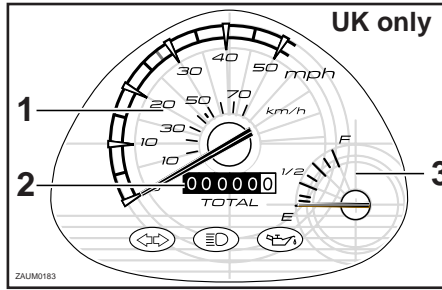

1. Speedometer
2. Odometer
3. Fuel gauge

EAU00113



Fuel gauge

The fuel gauge indicates the amount of fuel in the fuel tank. The needle moves towards "E" (Empty) as the fuel level decreases. When the needle reaches "E", refuel as soon as possible.

NOTE : _____
Do not allow the fuel tank to empty itself completely.

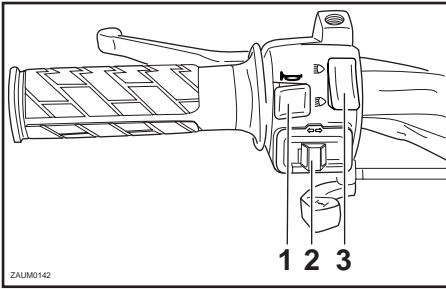
INSTRUMENT AND CONTROL FUNCTIONS



1. Horn switch “”
2. Turn signal switch “”
3. Dimmer switch “”

EAU00118

Handlebar switches

EAU00129

Horn switch “”

Press this switch to sound the horn.



EAU00125

Turn signal switch “”

To signal a right-hand turn, push this switch to the right. To signal a left-hand turn, push this switch to the left. When released, the switch returns to the center position. To cancel the turn signal lights, push the switch in after it has returned to the center position.

EAU03888

Dimmer switch “”

Set this switch to “” for the high beam and to “” for the low beam.

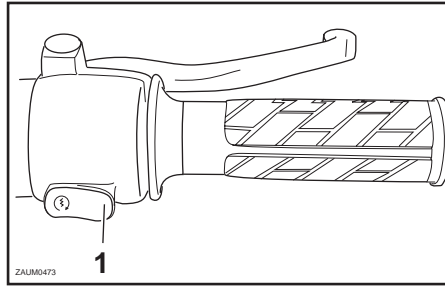

1. Start switch “”

EAU00063

Start switch “”

Push this switch while applying the front or rear brake to crank the engine with the starter.

EC000005

CAUTION:

See page 5-1 for starting instructions prior to starting the engine.

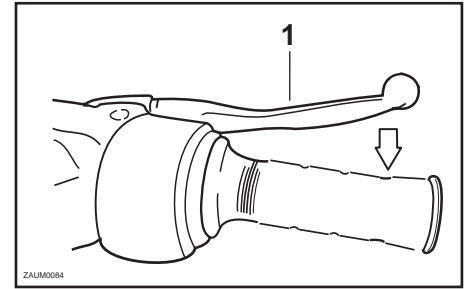

1. Front brake lever

EAU03882

Front brake lever

The front brake lever is located on the right handlebar grip. To apply the front brake, pull this lever toward the handlebar grip.

INSTRUMENT AND CONTROL FUNCTIONS

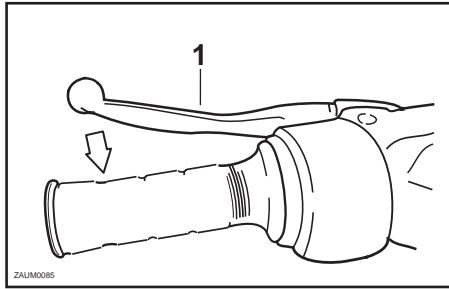

1. Rear brake lever

EAU00163

Rear brake lever

The rear brake lever is located on the left handlebar grip. To apply the rear brake, pull this lever toward the handlebar grip.

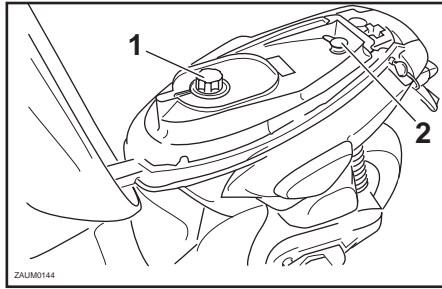

1. Fuel tank cap
2. Oil tank cap

EAU03463

Fuel and 2-stroke engine oil tank caps

The fuel tank cap and the 2-stroke engine oil tank cap are located under the seat. (See page 3-8 for seat opening and closing procedures.)

Fuel tank cap

To remove the fuel tank cap, turn it counterclockwise, and then pull it off. To install the fuel tank cap, turn it clockwise.

2-stroke engine oil tank cap

To remove the 2-stroke engine oil tank cap, pull it off.

To install the 2-stroke engine oil tank cap, push it into the oil tank opening.

EW000025

⚠ WARNING

Make sure that the fuel and 2-stroke engine oil tank caps are properly installed before riding the scooter.

INSTRUMENT AND CONTROL FUNCTIONS

EAU00185
EC000008

EWA00008

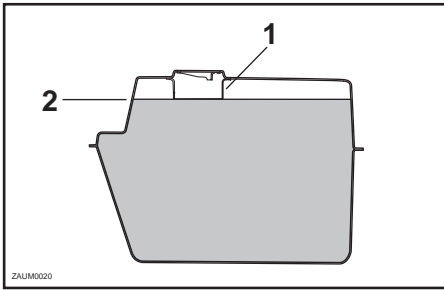

1. Filler tube
2. Fuel level

EAU03753

Fuel

Make sure that there is sufficient fuel in the tank. Fill the fuel tank to the bottom of the filler tube as shown.

⚠ WARNING

EW000130

- **Do not overfill the fuel tank, otherwise it may overflow when the fuel warms up and expands.**
- **Avoid spilling fuel on the hot engine.**

CAUTION:

Immediately wipe off spilled fuel with a clean, dry, soft cloth, since fuel may deteriorate painted surfaces or plastic parts.

EAU04206*

Recommended fuel:
REGULAR UNLEADED
GASOLINE ONLY
Fuel tank capacity:
Total amount:
6.5 L

Your Yamaha engine has been designed to use regular unleaded gasoline with a research octane number of 91 or higher. If knocking (or pinging) occurs, use a gasoline of a different brand or premium unleaded fuel. Use of unleaded fuel will extend spark plug life and reduce maintenance costs.

⚠ WARNING

Since gasoline is flammable, the following precautions must be observed.

- Stop the engine before refueling.
- Never attempt to refuel the scooter while smoking or near an open flame.
- Take special care not to spill gasoline over the engine or muffler when refueling immediately after operation.
- Before starting the engine, quickly wipe off any gasoline spilled on the engine or muffler.

INSTRUMENT AND CONTROL FUNCTIONS

2-stroke engine oil

EAU03750

Make sure that there is sufficient oil in the 2-stroke engine oil tank. Add the recommended 2-stroke engine oil if necessary.

NOTE :

Make sure that the 2-stroke engine oil tank cap is properly installed.

Recommended oil:

Yamalube 2 or equivalent 2-stroke engine oil (JASO grade "FC", or ISO grades "EG-C" or "EG-D")

Oil quantity:
1.3 L

Catalytic converter

EAU03098

This scooter is equipped with a catalytic converter in the muffler.

⚠ WARNING

EW000128

The exhaust system is hot after operation. Make sure that the exhaust system has cooled down before doing any maintenance work.

CAUTION:

EC000114

The following precautions must be observed to prevent a fire hazard or other damages.

- Use only unleaded gasoline. The use of leaded gasoline will cause unreparable damage to the catalytic converter.
- Never park the scooter near possible fire hazards such as grass or other materials that easily burn.
- Do not allow the engine to idle too long.

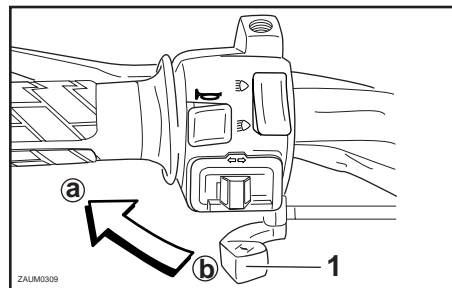

1. Starter (choke) lever “”

Starter (choke) lever “”

EAU03839

Starting a cold engine requires a richer air-fuel mixture, which is supplied by the starter (choke).

Move the lever in direction (a) to turn on the starter (choke).

Move the lever in direction (b) to turn off the starter (choke).

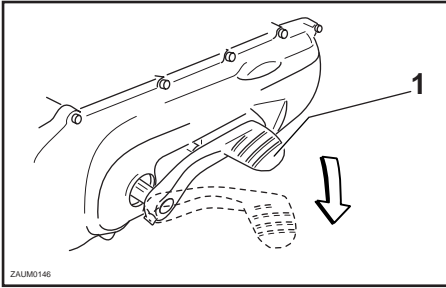

1. Kick starter

Kickstarter

EAUS0015

To start the engine, push the kickstarter down lightly with your foot until the gears engage, and then push it down smoothly but forcefully.

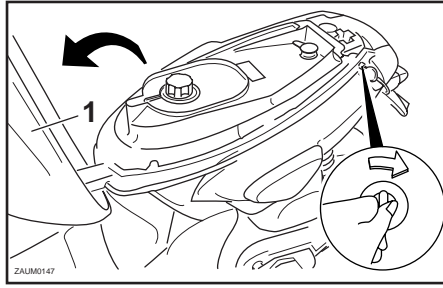

1. Seat

Seat

EAU02978

To open the seat

1. Insert the key in the lock, and then turn it as shown.
2. Fold the seat up.

To close the seat

1. Fold the seat down, and then push it down to lock it in place.
2. Remove the key.

NOTE : _____

Make sure that the seat is properly secured before riding.

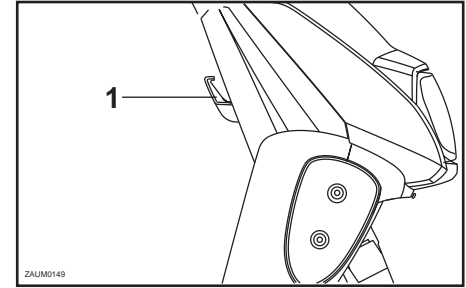

1. Luggage hook

Luggage hook

EAUT0020

EWAT0002

⚠ WARNING

- Do not exceed the load limit of 3.0 kg for the luggage hook.
 - Do not exceed the maximum load of 184 kg for the vehicle.
-

INSTRUMENT AND CONTROL FUNCTIONS

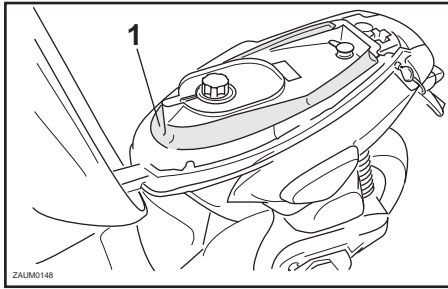

1. Anti-theft device housing

EAUM0114

Anti-theft device housing

The anti-theft device housing, located under the seat, is designed to store a joint type anti-theft device with a maximum length of 1 meter. (See page 3-8 for seat opening and closing procedures.)

NOTE : _____

Some anti-theft devices cannot fit into the housing due to their size or shape.

PRE-OPERATION CHECKS

Pre-operation check list 4-1

PRE-OPERATION CHECKS

The condition of a vehicle is the owner's responsibility. Vital components can start to deteriorate quickly and unexpectedly, even if the vehicle remains unused (for example, as a result of exposure to the elements). Any damage, fluid leakage or loss of tire air pressure could have serious consequences. Therefore, it is very important, in addition to a thorough visual inspection, to check the following points before each ride.

EAU03439

Pre-operation check list

ITEM	CHECKS	PAGE
Fuel	<ul style="list-style-type: none">• Check fuel level in fuel tank.• Refuel if necessary.• Check fuel line for leakage.	3-6
Two-stroke engine oil	<ul style="list-style-type: none">• Check oil level in oil tank.• If necessary, add recommended oil to specified level.• Check vehicle for oil leakage.	3-7
Final transmission oil	<ul style="list-style-type: none">• Check oil level and vehicle for oil leakage.	6-6
Front brake	<ul style="list-style-type: none">• Check operation.• If soft or spongy, have Yamaha dealer bleed hydraulic system.• Check fluid level in reservoir.• If necessary, add recommended brake fluid to specified level.• Check hydraulic system for leakage.	3-4, 6-11
Rear brake	<ul style="list-style-type: none">• Check operation.• Check lever free play.• Adjust if necessary.	3-5, 6-11
Throttle grip	<ul style="list-style-type: none">• Make sure that operation is smooth.• Check cable free play.• If necessary, have Yamaha dealer adjust cable free play and lubricate cable and grip housing.	6-8

PRE-OPERATION CHECKS

ITEM	CHECKS	PAGE
Wheels and Tires	<ul style="list-style-type: none">• Check for damage.• Check tire condition and tread depth.• Check air pressure.• Correct if necessary.	6-9 — 6-11
Brake levers	<ul style="list-style-type: none">• Make sure that operation is smooth.• Lubricate lever pivoting points if necessary.	3-4 — 3-5
Centerstand	<ul style="list-style-type: none">• Make sure that operation is smooth.• Lubricate pivot if necessary.	6-15
Chassis-fasteners	<ul style="list-style-type: none">• Make sure that all nuts, bolts and screws are properly tightened.• Tighten if necessary.	—
Instruments, lights signals and switches	<ul style="list-style-type: none">• Check operation.• Correct if necessary.	3-1 — 3-4, 6-20 — 6-21
Battery	<ul style="list-style-type: none">• Check fluid level.• Fill with distilled water if necessary.	6-17

NOTE : _____

Pre-operation checks should be made each time the scooter is used. Such an inspection can be accomplished in a very short time; and the added safety it assures is more than worth the time involved.

⚠ WARNING _____

EWA00033

If any item in the Pre-operation check list is not working properly, have it inspected and repaired before operating the scooter.

OPERATION AND IMPORTANT RIDING POINTS

Starting the engine	5-1
Starting a warm engine	5-2
Starting off	5-2
Acceleration and deceleration	5-3
Braking	5-3
Tips for reducing fuel consumption	5-3
Engine break-in	5-4
Parking	5-5

OPERATION AND IMPORTANT RIDING POINTS

EAU01118
EW000129

⚠ WARNING

- Become thoroughly familiar with all operating controls and their functions before riding. Consult a Yamaha dealer regarding any control or function that you do not thoroughly understand.
- Never start the engine or operate it in a closed area for any length of time. Exhaust fumes are poisonous, and inhaling them can cause loss of consciousness and death within a short time. Always make sure that there is adequate ventilation.
- For safety, always start the engine with the centerstand down.

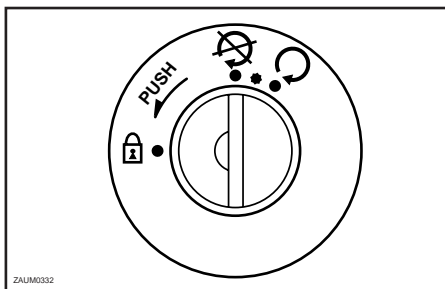

EAU00415*

Starting the engine

1. Turn the key to “*”, then when the oil level warning light comes on, turn it to “O”.

EC000045

CAUTION:

If the oil level warning light does not come on, have a Yamaha dealer check the electrical circuit.

2. Turn the starter (choke) on and completely close the throttle. (See page 3-7 for starter (choke) operation.)

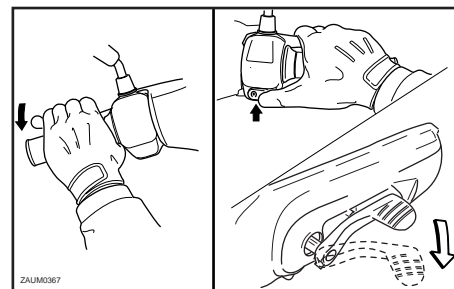

3. Start the engine by pushing the start switch or by pushing the kickstarter lever down, while applying the front or rear brake.

NOTE :

If the engine fails to start by pushing the start switch, release the switch, wait a few seconds, and then try again. Each starting attempt should be as short as possible to preserve the battery. Do not crank the engine more than 5 seconds on any one attempt. If the engine does not start with the starter motor, try using the kickstarter.

4. After starting the engine, move the starter (choke) knob/lever back halfway.

OPERATION AND IMPORTANT RIDING POINTS

CAUTION:

ECA00045

For maximum engine life, never accelerate hard when the engine is cold!

5. When the engine is warm, turn the starter (choke) off.

NOTE :

The engine is warm when it responds normally to the throttle with the starter (choke) turned off.

CAUTION:

EC000046

See page 5-4 for engine break-in instructions prior to operating the vehicle for the first time.

Starting a warm engine

EAU01258

Follow the same procedure as for starting a cold engine with the exception that the starter (choke) is not required when the engine is warm.

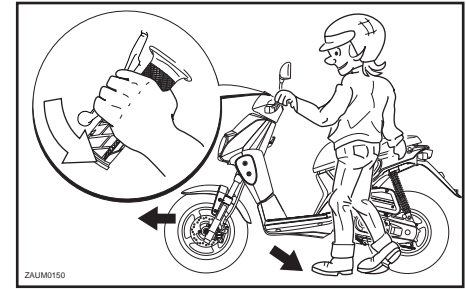

ZAJM0150

EAU00433

Starting off

NOTE :

Before starting off, allow the engine to warm up.

1. While pulling the rear brake lever with your left hand and holding the grab bar with your right hand, push the scooter off the centerstand.
2. Sit astride the seat, and then adjust the rear view mirrors.
3. Switch the turn signal on.
4. Check for oncoming traffic, and then slowly turn the throttle grip (on the right) in order to take off.
5. Switch the turn signal off.

OPERATION AND IMPORTANT RIDING POINTS

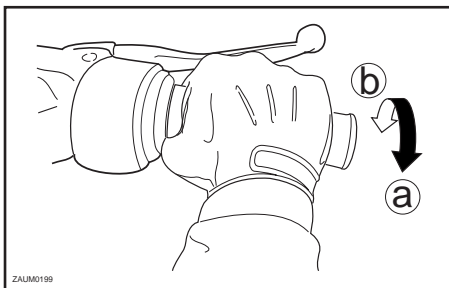

EAU00434

Acceleration and deceleration

The speed can be adjusted by opening and closing the throttle. To increase the speed, turn the throttle grip in direction **a** . To reduce the speed, turn the throttle grip in direction **b** .

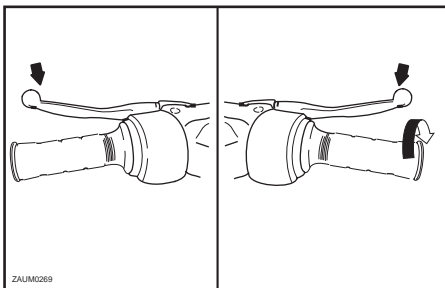

EAU00435

Braking

1. Close the throttle completely.
2. Apply both front and rear brakes simultaneously while gradually increasing the pressure.

⚠ WARNING

EW000057

- Avoid braking hard or suddenly (especially when leaning over to one side), otherwise the scooter may skid or overturn.
- Railroad crossings, streetcar rails, iron plates on road construction sites, and manhole covers become extremely slippery when wet. Therefore, slow down when approaching such areas and cross them with caution.
- Keep in mind that braking on a wet road is much more difficult.
- Ride slowly down a hill, as braking downhill can be very difficult.

Tips for reducing fuel consumption

EAU03093

Fuel consumption depends largely on your riding style. Consider the following tips to reduce fuel consumption:

- Thoroughly warm up the engine.
- Avoid high engine speeds during acceleration.
- Avoid high engine speeds with no load on the engine.
- Turn the engine off instead of letting it idle for an extended length of time (e.g., in traffic jams, at traffic lights or at railroad crossings).

Engine break-in

EAU00436

There is never a more important period in the life of your engine than the period between 0 and 1,000 km. For this reason, you should read the following material carefully.

Since the engine is brand new, do not put an excessive load on it for the first 1,000 km. The various parts in the engine wear and polish themselves to the correct operating clearances. During this period, prolonged full-throttle operation or any condition that might result in engine overheating must be avoided.

EAUT0003*

0 - 150 km

Avoid operation above 1/3 throttle. Stop the engine and let it cool for 5 to 10 minutes after every hour of operation. Vary the speed of the scooter from time to time. Do not operate it at one set throttle position.

150 - 500 km

Avoid prolonged operation above 1/2 throttle.

500 - 1,000 km

Avoid cruising speeds in excess of 3/4 throttle.

CAUTION:

ECAT0001*

After 1,000 km of operation, be sure to replace the final transmission oil.

1,000 km and beyond

Avoid prolonged full throttle operation. Vary speeds occasionally.

CAUTION:

EC000049

If any engine trouble should occur during the engine break-in period, immediately have a Yamaha dealer check the vehicle.

OPERATION AND IMPORTANT RIDING POINTS

EAU00461

Parking

When parking, stop the engine, and then remove the key from the main switch.

EW000058

⚠ WARNING

- Since the engine and exhaust system can become very hot, park in a place where pedestrians or children are not likely to touch them.
- Do not park on a slope or on soft ground, otherwise the scooter may overturn.

5

EC000062

CAUTION:

Never park in an area where there are fire hazards such as grass or other flammable materials.

PERIODIC MAINTENANCE AND MINOR REPAIR

Periodic maintenance and lubrication chart	6-2	Checking and lubricating the throttle grip and cable	6-15
Checking the spark plug	6-5	Lubricating the front and rear brake levers	6-15
Final transmission oil	6-6	Checking and lubricating the centerstand	6-15
Cleaning the air filter element	6-7	Checking the front fork	6-16
Adjusting the carburetor	6-8	Checking the steering	6-16
Adjusting the throttle cable free play	6-8	Checking the wheel bearings	6-17
Tires	6-9	Battery	6-17
Cast wheels	6-11	Replacing the fuse	6-19
Adjusting the front brake lever free play	6-11	Replacing a headlight bulb	6-20
Adjusting the rear brake lever free play	6-11	Replacing a front turn signal light bulb	6-21
Checking the front brake pads and rear brake shoes	6-12	Replacing a rear turn signal light bulb or the tail/brake light bulb	6-21
Checking the brake fluid level	6-13	Troubleshooting	6-21
Changing the brake fluid	6-14	Troubleshooting chart	6-22
Checking and lubricating the cables	6-14		

PERIODIC MAINTENANCE AND MINOR REPAIR

EAU03453

Safety is an obligation of the owner. Periodic inspection, adjustment and lubrication will keep your vehicle in the safest and most efficient condition possible. The most important points of scooter inspection, adjustment, and lubrication are explained on the following pages.

EW000060

⚠ WARNING

If you are not familiar with scooter maintenance work, have a Yamaha dealer do it for you.

EAU00466*
EW000061

⚠ WARNING

This scooter is designed for use on paved roads only. If this scooter is operated in abnormally dusty, muddy or wet conditions, the air filter element should be cleaned or replaced more frequently, otherwise rapid engine wear may result. Consult a Yamaha dealer for proper maintenance intervals.

EW000063

⚠ WARNING

Modifications not approved by Yamaha may cause loss of performance and render the vehicle unsafe for use. Consult a Yamaha dealer before attempting any changes.

PERIODIC MAINTENANCE AND MINOR REPAIR

EAU03686

Periodic maintenance and lubrication chart

NOTE :

- The annual checks must be performed every year, except if a kilometer-based maintenance is performed instead.
- From 30,000 km, repeat the maintenance intervals starting from 6,000 km.
- Items marked with an asterisk should be performed by a Yamaha dealer as they require special tools, data and technical skills.

NO.	Item	Check or maintenance job	ODOMETER READING (x 1,000 km)					ANNUAL CHECK
			1	6	12	18	24	
1	* Fuel line	• Check fuel hoses and vacuum hose for cracks or damage.		√	√	√	√	√
2	Spark plug	• Replace.		√	√	√	√	√
3	Air filter element	• Clean.		√		√		
		• Replace.			√		√	
4	* Battery	• Check electrolyte level and specific gravity. • Make sure that the breather hose is properly routed.		√	√	√	√	√
5	* Front brake	• Check operation, fluid level and vehicle for fluid leakage. (See NOTE on page 6-4.)	√	√	√	√	√	√
		• Replace brake pads.	Whenever worn to the limit					
6	* Rear brake	• Check operation and adjust brake lever freeplay.	√	√	√	√	√	√
		• Replace brake shoes.	Whenever worn to the limit					
7	* Brake hose	• Check for cracks or damage.		√	√	√	√	√
		• Replace. (See NOTE on page 6-4.)	Every 4 years					
8	* Wheels	• Check runout and for damage.		√	√	√	√	

PERIODIC MAINTENANCE AND MINOR REPAIR

NO.	Item	Check or maintenance job	ODOMETER READING (x 1,000 km)					ANNUAL CHECK
			1	6	12	18	24	
9	* Tires	<ul style="list-style-type: none"> • Check tread depth and for damage. • Replace if necessary. • Check air pressure. • Correct if necessary. 		√	√	√	√	√
10	* Wheel bearings	<ul style="list-style-type: none"> • Check bearing for looseness or damage. 		√	√	√	√	
11	* Steering bearings	<ul style="list-style-type: none"> • Check bearing play and steering for roughness. • Lubricate with lithium-soap-based grease. 	√	√	√	√	√	
12	* Chassis fasteners	<ul style="list-style-type: none"> • Make sure that all nuts, bolts and screws are properly tightened. 		√	√	√	√	√
13	Centerstand	<ul style="list-style-type: none"> • Check operation. • Lubricate. 		√	√	√	√	√
14	* Front fork	<ul style="list-style-type: none"> • Check operation and for oil leakage. 		√	√	√	√	
15	* Rear shock absorber assembly	<ul style="list-style-type: none"> • Check operation and shock absorber for oil leakage. 		√	√	√	√	
16	* Carburetor	<ul style="list-style-type: none"> • Adjust engine idling speed. 	√	√	√	√	√	√
17	* Autolube pump	<ul style="list-style-type: none"> • Check operation. • Bleed if necessary. 	√		√		√	√
18	Final transmission oil	<ul style="list-style-type: none"> • Check vehicle for oil leakage. • Change. 	√	√		√		
19	* V-belt	<ul style="list-style-type: none"> • Replace. 	Every 10,000 km					

6

PERIODIC MAINTENANCE AND MINOR REPAIR

NO.	Item	Check or maintenance job	ODOMETER READING (x 1,000 km)					ANNUAL CHECK
			1	6	12	18	24	
20	* Front and rear brake switches	• Check operation.	√	√	√	√	√	√
21	Moving parts and cables	• Lubricate.		√	√	√	√	√
22	* Throttle grip housing and cable	• Check operation and free play. • Adjust the throttle cable free play if necessary. • Lubricate the throttle grip housing and cable.		√	√	√	√	√
23	* Lights, signals and switches	• Check operation. • Adjust headlight beam.	√	√	√	√	√	√

EAU03541*

NOTE : _____

- The air filter needs more frequent service if you are riding in unusually wet or dusty areas.
- Hydraulic brake service
 - Regularly check and, if necessary, correct the brake fluid level.
 - Every two years change the brake fluid.
 - Replace the brake hoses every four years and if cracked or damaged.

PERIODIC MAINTENANCE AND MINOR REPAIR

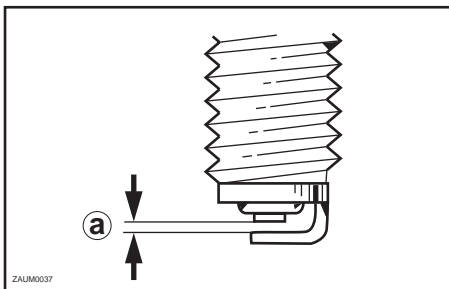

a. Spark plug gap

EAU01651

Checking the spark plug

The spark plug is an important engine component, which should be checked periodically, preferably by a Yamaha dealer. Since heat and deposits will cause any spark plug to slowly erode, it should be removed and checked in accordance with the periodic maintenance and lubrication chart. In addition, the condition of the spark plug can reveal the condition of the engine.

The porcelain insulator around the center electrode of the spark plug should be a medium-to-light tan (the ideal color when the scooter is ridden normally). If the spark plug shows a distinctly different color, the engine could be defective. Do not attempt to diagnose such problems yourself. Instead, have a Yamaha dealer check the scooter.

If the spark plug shows signs of electrode erosion and excessive carbon or other deposits, it should be replaced.

Specified spark plug:
BR8HS (NGK)
or BR9HS (NGK)

Before installing a spark plug, the spark plug gap should be measured with a wire thickness gauge and, if necessary, adjusted to specification.

Spark plug gap:
0.5 - 0.7 mm

Clean the surface of the spark plug gasket and its mating surface, and then wipe off any grime from the spark plug threads.

Tightening torque:
Spark plug:
20 Nm (2.0 m·kg)

NOTE :

If a torque wrench is not available when installing a spark plug, a good estimate of the correct torque is 1/4 - 1/2 turn past finger tight. However, the spark plug should be tightened to the specified torque as soon as possible.

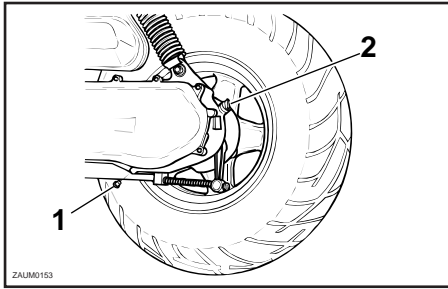

1. Final transmission oil drain bolt
2. Final transmission oil filler cap

EAU04228

Final transmission oil

The final transmission case must be checked for oil leakage before each ride. If any leakage is found, have a Yamaha dealer check and repair the scooter. In addition, the final transmission oil must be changed as follows at the intervals specified in the periodic maintenance and lubrication chart.

1. Start the engine, warm it up by riding the scooter for several minutes, and then stop the engine.
2. Place the scooter on the centerstand.

3. Place an oil pan under the final transmission case to collect the used oil.
4. Remove the oil filler cap and drain bolt to drain the oil from the final transmission case.
5. Install the final transmission oil drain bolt, and then tighten it to the specified torque.

Tightening torque:

Final transmission oil drain bolt:
17 Nm (1.7 m·kgf)

6. Add the specified amount of the recommended final transmission oil, and then install and tighten the oil filler cap.

Recommended final transmission oil:

See page 8-1.

Oil quantity:
0.11 L

⚠ WARNING

- Make sure that no foreign material enters the final transmission case.
 - Make sure that no oil gets on
7. Check the final transmission case for oil leakage. If oil is leaking, check for the cause.

PERIODIC MAINTENANCE AND MINOR REPAIR

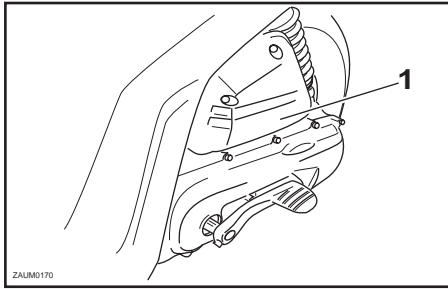

1. Air filter case cover

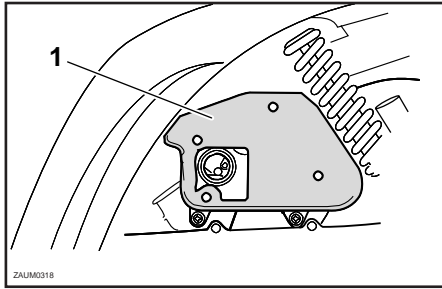

1. Air filter element

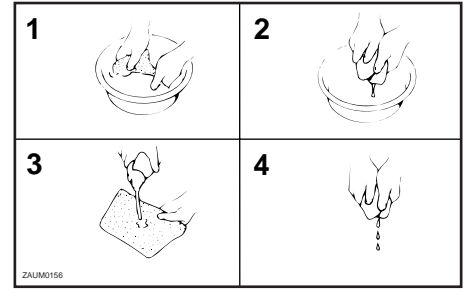

Cleaning the air filter element

The air filter element should be cleaned at the intervals specified in the periodic maintenance and lubrication chart. Clean the air filter element more frequently if you are riding in unusually wet or dusty areas.

1. Remove the air filter case cover by removing the screws.

EAM0071

2. Pull the air filter element out, clean it with solvent, and then squeeze the remaining solvent out.

EW000075

⚠ WARNING

Use only a dedicated parts cleaning solvent. To avoid the risk of fire or explosion, do not use gasoline or solvents with a low flash point.

EC000089

CAUTION:

To avoid damaging the foam material, handle it gently and carefully, and do not twist or wring it.

3. Apply oil of the recommended type to the entire surface of the element, and then squeeze the excess oil out.

NOTE :

The air filter element should be wet but not dripping.

Recommended oil:
Engine oil

PERIODIC MAINTENANCE AND MINOR REPAIR

4. Insert the element into the air filter case.

CAUTION:

EC000082

- **Make sure that the air filter element is properly seated in the air filter case.**
- **The engine should never be operated without the air filter element installed, otherwise the piston(s) and/or cylinder(s) may become excessively worn.**

5. Install the air filter case cover by installing the screws.

Adjusting the carburetor

EAU00631

The carburetor is an important part of the engine and requires very sophisticated adjustment. Therefore, all carburetor adjustments should be left to a Yamaha dealer, who has the necessary professional knowledge and experience.

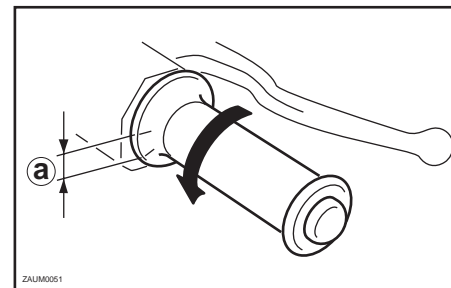

a. Throttle cable free play

Adjusting the throttle cable free play

EAU00635

The throttle cable free play should measure 1.5 - 3.0 mm at the throttle grip. Periodically check the throttle cable free play and, if necessary, have a Yamaha dealer adjust it.

PERIODIC MAINTENANCE AND MINOR REPAIR

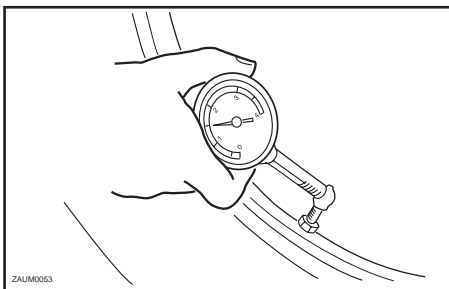

ZAU00053

EAU04551*

Tires

To maximize the performance, durability, and safe operation of your scooter, note the following points regarding the specified tires.

Tire air pressure

The tire air pressure should be checked and, if necessary, adjusted before each ride.

⚠ WARNING

EW000082

- The tire air pressure must be checked and adjusted on cold tires (i.e., when the temperature of the tires equals the ambient temperature).
- The tire air pressure must be adjusted in accordance with the riding speed and with the total weight of rider, passenger, cargo, and accessories approved for this model.

⚠ WARNING

EW000077

Because loading has an enormous impact on the handling, braking, performance and safety characteristics of your scooter, you should keep the following precautions in mind.

- **NEVER OVERLOAD THE SCOOTER!** Operation of an overloaded scooter may result in tire damage, loss of control, or severe injury. Make sure that the total weight of rider, cargo, and accessories does not exceed the specified maximum load for the vehicle.
- Do not carry along loosely packed items, which can shift during a ride.
- Securely pack the heaviest items close to the center of the scooter and distribute the weight evenly on both sides.
- Adjust the suspension and tire air pressure with regard to the load. Check the tire condition and air pressure before each ride.

Tire air pressure
(measured on cold tires)

Load*	Front	Rear
Up to 90 kg	150 kPa 1.5 kgf/cm ² 1.5 bar	150 kPa 1.5 kgf/cm ² 1.5 bar
90 kg load-maximum	150 kPa 1.5 kgf/cm ² 1.5 bar	170 kPa 1.7 kgf/cm ² 1.7 bar

Maximum load*	184 kg
---------------	--------

* Total weight of rider, passenger, cargo and accessories

PERIODIC MAINTENANCE AND MINOR REPAIR

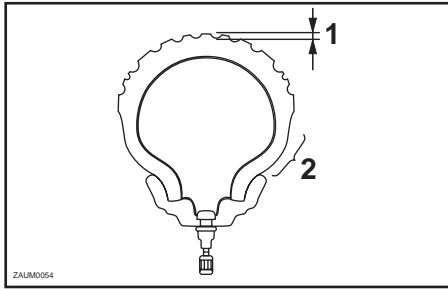

1. Tread depth
2. Side wall

Tire inspection

The tires must be checked before each ride. If the center tread depth reaches the specified limit, if the tire has a nail or glass fragments in it, or if the sidewall is cracked, have a Yamaha dealer replace the tire immediately.

Minimum tire tread depth (front and rear)	1.6 mm
---	--------

NOTE :

The tire tread depth limits may differ from country to country. Always comply with the local regulations.

EW000079

⚠ WARNING

- Have a Yamaha dealer replace excessively worn tires. Besides being illegal, operating the scooter with excessively worn tires decreases riding stability and can lead to loss of control.
- The replacement of all wheel and brake related parts, including the tires, should be left to a Yamaha dealer, who has the necessary professional knowledge and experience.

Tire information

This scooter is equipped with tubeless tires.

Front

Manufacturer	Size	Type
MICHELIN	120/80-12 55L	BOPPER
CHENG SHIN	120/80-12 55J	MAXXIS

Rear

Manufacturer	Size	Type
MICHELIN	130/90-10 61L	BOPPER
CHENG SHIN	130/90-10 61J	MAXXIS

PERIODIC MAINTENANCE AND MINOR REPAIR

Cast wheels

EAU03773

To maximize the performance, durability, and safe operation of your scooter, note the following points regarding the specified wheels.

- The wheel rims should be checked for cracks, bends or warpage before each ride. If any damage is found, have a Yamaha dealer replace the wheel. Do not attempt even the smallest repair to the wheel. A deformed or cracked wheel must be replaced.
- The wheel should be balanced whenever either the tire or wheel has been changed or replaced. An unbalanced wheel can result in poor performance, adverse handling characteristics, and a shortened tire life.
- Ride at moderate speeds after changing a tire since the tire surface must first be "broken in" for it to develop its optimal characteristics.

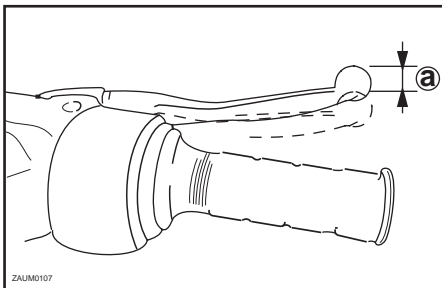

a. Front brake lever free play

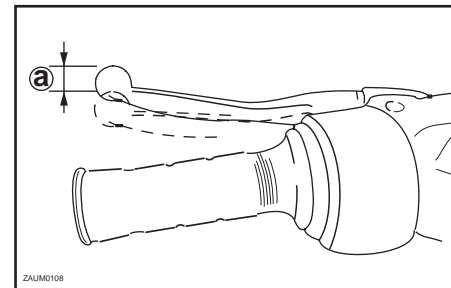

a. Rear brake lever free play

EAU00697*

Adjusting the front brake lever free play

The brake lever free play should measure 10 - 20 mm as shown. Periodically check the brake lever free play and, if necessary, have a Yamaha dealer adjust it.

EW000100

⚠ WARNING

An incorrect brake lever free play indicates a hazardous condition in the brake system. Do not operate the scooter until the brake system has been checked or repaired by a Yamaha dealer.

EAU04469

Adjusting the rear brake lever free play

The brake lever free play should measure 10 - 20 mm as shown. Periodically check the brake lever free play and, if necessary, adjust it as follows.

PERIODIC MAINTENANCE AND MINOR REPAIR

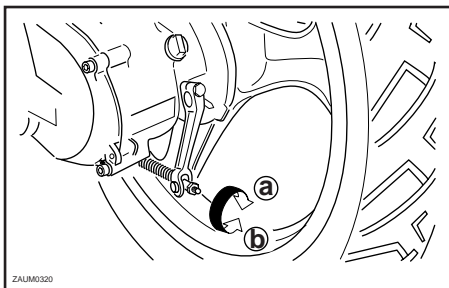

To increase the brake lever free play, turn the adjusting nut at the brake shoe plate in direction **a** . To decrease the brake lever free play, turn the adjusting nut in direction **b** .

⚠ WARNING

EW000101

If proper adjustment cannot be obtained as described, have a Yamaha dealer make this adjustment.

EAU00720

Checking the front brake pads and rear brake shoes

The front brake pads and the rear brake shoes must be checked for wear at the intervals specified in the periodic maintenance and lubrication chart.

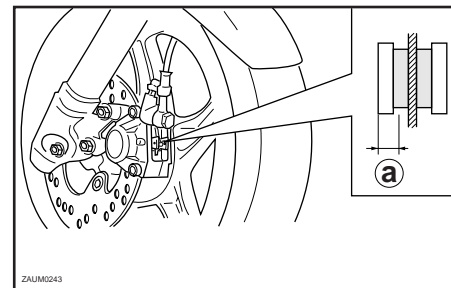

a. Wear limit

EAU01436

Front brake pads

Check each front brake pad for damage and measure the lining thickness. If a brake pad is damaged or if the lining thickness is less than 3.1 mm, have a Yamaha dealer replace, the brake pads as a set.

PERIODIC MAINTENANCE AND MINOR REPAIR

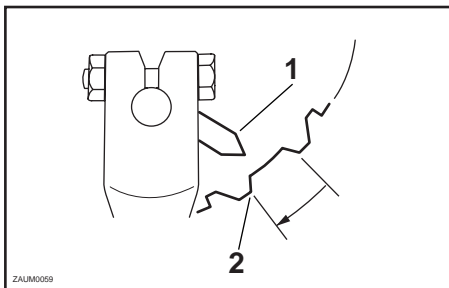

1. Wear indicator
2. Wear limit

Rear brake shoes

The rear brake is provided with a wear indicator, which allows you to check the brake shoe wear without having to disassemble the brake. To check the brake shoe wear, check the position of the wear indicator while applying the brake. If a brake shoe has worn to the point that the wear indicator reaches the wear limit line, have a Yamaha dealer replace the brake shoes as a set.

EAU04502

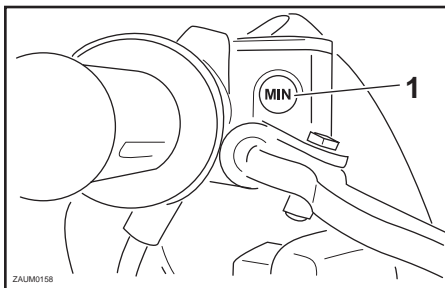

1. Minimum level mark

EAU00732

Checking the brake fluid level

Insufficient brake fluid may allow air to enter the brake system, possibly causing it to become ineffective.

Before riding, check that the brake fluid is above the minimum level mark and replenish if necessary. A low brake fluid level may indicate worn brake pads and/or brake system leakage. If the brake level is low, be sure to check the brake pads for wear and the brake system for leakage.

Observe these precautions:

- When checking the fluid level, make sure that the top of the master cylinder is level by turning the handlebars.
- Use only the recommended quality brake fluid, otherwise the rubber seals may deteriorate, causing leakage and poor braking performance.

Recommended brake fluid:
DOT 4

NOTE :

If DOT 4 is not available, DOT 3 can be used.

- Refill with the same type of brake fluid. Mixing fluids may result in a harmful chemical reaction and lead to poor braking performance.
- Be careful that water does not enter the master cylinder when refilling. Water will significantly lower the boiling point of the fluid and may result in vapor lock.

PERIODIC MAINTENANCE AND MINOR REPAIR

- Brake fluid may deteriorate painted surfaces or plastic parts. Always clean up spilled fluid immediately.
- As the brake pads wear, it is normal for the brake fluid level to gradually go down. However, if the brake fluid level goes down suddenly, have a Yamaha dealer check the cause.

Changing the brake fluid

EAUM0008

Have a Yamaha dealer change the brake fluid at the intervals specified in the periodic maintenance and lubrication chart. In addition, have the brake hose replaced every four years or whenever it is damaged or leaking.

Checking and lubricating the cables

EAU02962

The operation of all control cables and the condition of the cables should be checked before each ride, and the cables and cable ends should be lubricated if necessary. If a cable is damaged or does not move smoothly, have a Yamaha dealer check or replace it.

Recommended lubricant:
Engine oil

⚠ WARNING

EW000112

Damage to the outer sheath may interfere with proper cable operation and will cause the inner cable to rust. Replace a damaged cable as soon as possible to prevent unsafe conditions.

PERIODIC MAINTENANCE AND MINOR REPAIR

Checking and lubricating the throttle grip and cable

EAU04034

The operation of the throttle grip should be checked before each ride. In addition, the cable should be lubricated or replaced at the intervals specified in the periodic maintenance chart.

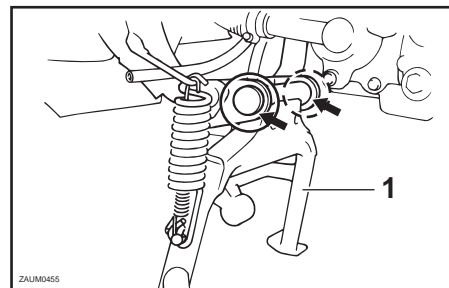
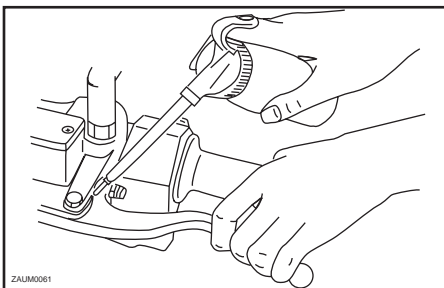

1. Centerstand

Lubricating the front and rear brake levers

EAU03118

The pivoting points of the front and rear brake levers must be lubricated at the intervals specified in the periodic maintenance and lubrication chart.

Recommended lubricant:
Lithium-soap-based grease
(all-purpose grease)

Checking and lubricating the centerstand

EAU04123

The operation of the centerstand should be checked before each ride, and the pivots and metal-to-metal contact surfaces should be lubricated if necessary.

⚠ WARNING

EWA00055

If the centerstand does not move up and down smoothly, have a Yamaha dealer check or repair it.

Recommended lubricant:
Lithium-soap-based grease
(all-purpose grease)

PERIODIC MAINTENANCE AND MINOR REPAIR

Checking the front fork

EAU02939

The condition and operation of the front fork must be checked as follows at the intervals specified in the periodic maintenance and lubrication chart.

To check the condition

EW000115

⚠ WARNING

Securely support the scooter so that there is no danger of it falling over.

Check the inner tubes for scratches, damage and excessive oil leakage.

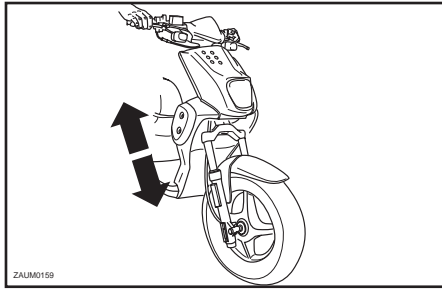

To check the operation

1. Place the scooter on a level surface and hold it in an upright position.
2. While applying the front brake, push down hard on the handlebars several times to check if the front fork compresses and rebounds smoothly.

CAUTION:

EC000098

If any damage is found or the front fork does not operate smoothly, have a Yamaha dealer check or repair it.

Checking the steering

EAU00794

Worn or loose steering bearings may cause danger. Therefore, the operation of the steering must be checked as follows at the intervals specified in the periodic maintenance and lubrication chart.

1. Place a stand under the engine to raise the front wheel off the ground.

⚠ WARNING

EW000115

Securely support the scooter so that there is no danger of it falling over.

PERIODIC MAINTENANCE AND MINOR REPAIR

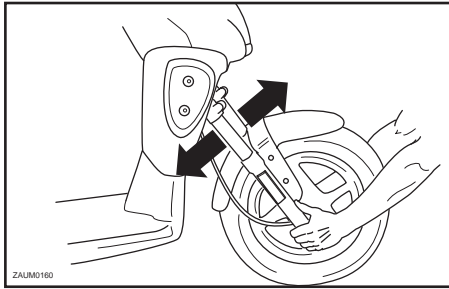

EAU01144

Checking the wheel bearings

The front and rear wheel bearings must be checked at the intervals specified in the periodic maintenance and lubrication chart. If there is play in the wheel hub or if the wheel does not turn smoothly, have a Yamaha dealer check the wheel bearings.

2. Hold the lower ends of the front fork legs and try to move them forward and backward. If any free play can be felt, have a Yamaha dealer check or repair the steering.

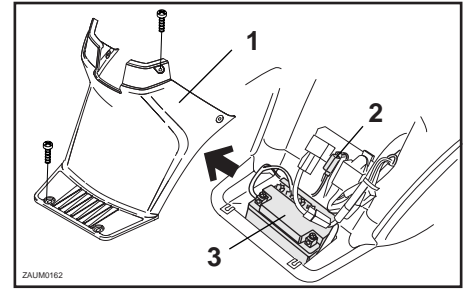

1. Panel A
2. Fuse
3. Battery

EAU0049*

Battery

A poorly maintained battery will corrode and discharge quickly. The electrolyte level, battery lead connections and breather hose routing should be checked before each ride and at the intervals specified in the periodic maintenance and lubrication chart.

PERIODIC MAINTENANCE AND MINOR REPAIR

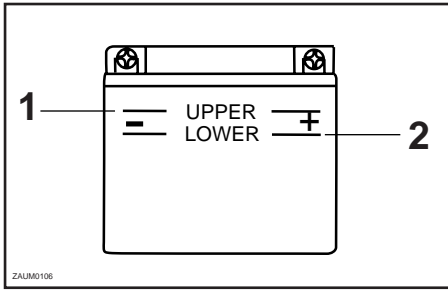

1. Maximum level
2. Minimum level

To check the electrolyte level

1. Place the scooter on a level surface and hold it in an upright position.

NOTE : _____
Make sure that the scooter is positioned straight up when checking the electrolyte level.

2. Remove panel A.
3. Check the electrolyte level in the battery.

NOTE : _____
The electrolyte should be between the minimum and maximum level marks.

4. If the electrolyte is at or below the minimum level mark, add distilled water to raise it to the maximum level mark.

⚠ WARNING _____

EW000116

- **Electrolyte is poisonous and dangerous since it contains sulfuric acid, which causes severe burns. Avoid any contact with skin, eyes or clothing and always shield your eyes when working near batteries. In case of contact, administer the following FIRST AID.**

- **EXTERNAL: Flush with plenty of water.**
- **INTERNAL: Drink large quantities of water or milk and immediately call a physician.**
- **EYES: Flush with water for 15 minutes and seek prompt medical attention.**

- **Batteries produce explosive hydrogen gas. Therefore, keep sparks, flames, cigarettes, etc., away from the battery and provide sufficient ventilation when charging it in an enclosed space.**
- **KEEP THIS AND ALL BATTERIES OUT OF THE REACH OF CHILDREN.**

EC000100

CAUTION: _____

Use only distilled water, as tap water contains minerals that are harmful to the battery.

5. Check and, if necessary, tighten the battery lead connections and correct the breather hose routing.

PERIODIC MAINTENANCE AND MINOR REPAIR

To store the battery

1. If the scooter will not be used for more than one month, remove the battery, fully charge it, and then place it in a cool, dry place.
2. If the battery will be stored for more than two months, check the specific gravity of the electrolyte at least once a month and fully charge the battery whenever necessary.
3. Fully charge the battery before installation.
4. After installation, make sure that the battery leads are properly connected to the battery terminals and that the breather hose is properly routed, in good condition, and not obstructed.

CAUTION:

EC000099

If the breather hose is positioned in such a way that the frame is exposed to electrolyte or gas expelled from the battery, the frame could suffer structural and external damages.

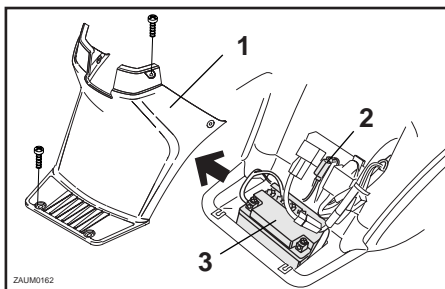

1. Panel A
2. Fuse
3. Battery

EAU00809*

Replacing the fuse

The fuse holder is located beside the battery compartment behind panel A. If the fuse is blown, replace it as follows.

1. Turn the key to “” and turn off all electrical circuits.
2. Remove the blown fuse, and then install a new fuse of the specified amperage.

Specified fuse:
7 A

EC000103

CAUTION:

Do not use a fuse of a higher amperage rating than recommended to avoid causing extensive damage to the electrical system and possibly a fire.

3. Turn the key to “” and turn on the electrical circuits to check if the devices operate.
4. If the fuse immediately blows again, have a Yamaha dealer check the electrical system.

PERIODIC MAINTENANCE AND MINOR REPAIR

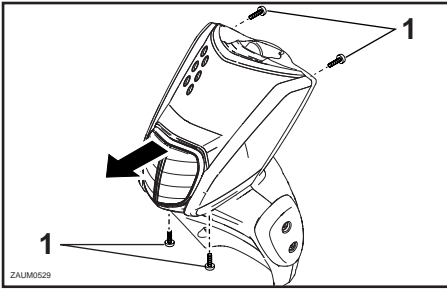

1. Screw (x4)

Replacing a headlight bulb

EAUM0072

1. Remove front cover by removing the screws.
2. Remove the headlight coupler.

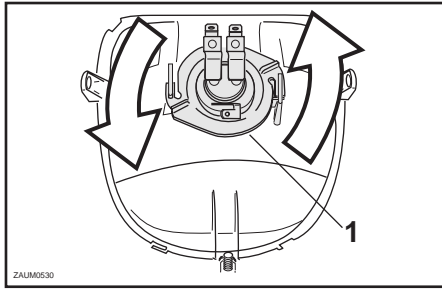

1. Headlight bulb holder
3. Remove the headlight bulb holder by turning it 1/4 turn counterclockwise.
4. Remove the defective bulb.

⚠ WARNING

EW000119

Headlight bulbs get very hot. Therefore, keep flammable products away from a lit headlight bulb, and do not touch the bulb until it has cooled down.

5. Place a new headlight bulb into position, and then secure it with the bulb holder.

6. Connect the headlight coupler and install the front cover.

EC000105

CAUTION:

Do not touch the glass part of the headlight bulb to keep it free from oil, otherwise the transparency of the glass, the luminosity of the bulb, and the bulb life will be adversely affected. Thoroughly clean off any dirt and fingerprints on the headlight bulb using a cloth moistened with alcohol or thinner.

PERIODIC MAINTENANCE AND MINOR REPAIR

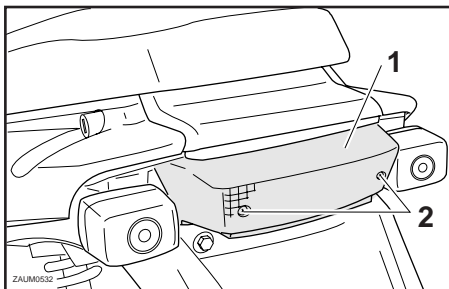

1. Lens
2. Screw (x2)

EAU01623

Replacing the tail/brake light bulb

1. Remove the tail/brake light lens by removing the screws.
2. Remove the defective bulb by pushing it in and turning it counterclockwise.
3. Insert a new bulb into the socket, push it in, and then turn it clockwise until it stops.
4. Install the lens by installing the screws.

EC000108

CAUTION:

Do not overtighten the screws, otherwise the lens may break.

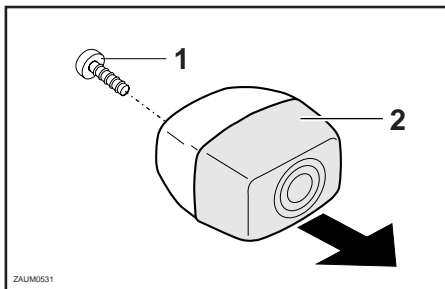

1. Screw
2. Lens

EAU03497

Replacing a turn signal light bulb

1. Remove the turn signal light lens by removing the screw.
2. Remove the defective bulb by pushing it in and turning it counterclockwise.
3. Insert a new bulb into the socket, push it in, and then turn it clockwise until it stops.
4. Install the lens by installing the screw.

ECA00065

CAUTION:

Do not overtighten the screw, otherwise the lens may break.

EAU01008

Troubleshooting

Although Yamaha scooters receive a thorough inspection before shipment from the factory, trouble may occur during operation. Any problem in the fuel, compression, or ignition systems, for example, can cause poor starting and loss of power.

The following troubleshooting chart represents a quick and easy procedure for checking these vital systems yourself. However, should your scooter require any repair, take it to a Yamaha dealer, whose skilled technicians have the necessary tools, experience, and know-how to service the scooter properly. Use only genuine Yamaha replacement parts. Imitation parts may look like Yamaha parts, but they are often inferior, have a shorter service life and can lead to expensive repair bills.

PERIODIC MAINTENANCE AND MINOR REPAIR

EAU03473

Troubleshooting chart

EW000125

⚠ WARNING

Keep away from open flames and do not smoke while checking or working on the fuel system.

1. Fuel

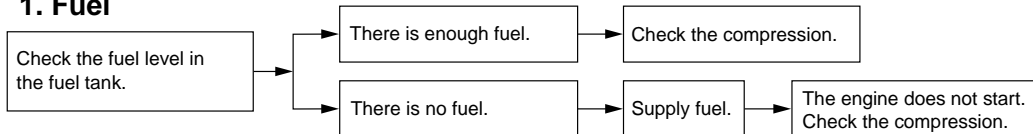

2. Compression

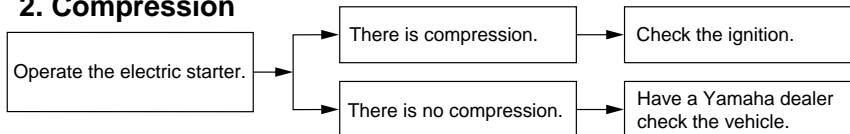

3. Ignition

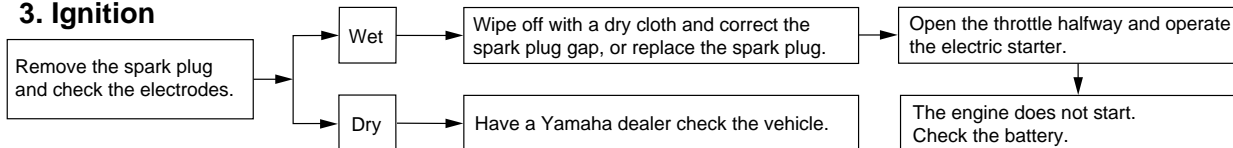

4. Battery

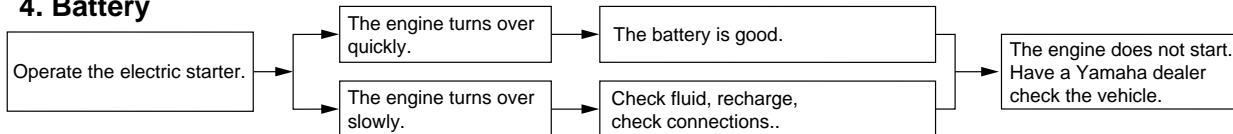

SCOOTER CARE AND STORAGE

Care 7-1
Storage 7-4

SCOOTER CARE AND STORAGE

Care

While the open design of a scooter reveals the attractiveness of the technology, it also makes it more vulnerable. Rust and corrosion can develop even if high-quality components are used. A rusty exhaust pipe may go unnoticed on a car, however, it detracts from the overall appearance of a scooter. Frequent and proper care does not only comply with the terms of the warranty, but it will also keep your scooter looking good, extend its life and optimize its performance.

Before cleaning

1. Cover the muffler outlet with a plastic bag after the engine has cooled down.
2. Make sure that all caps and covers as well as all electrical couplers and connectors, including the spark plug cap, are tightly installed.
3. Remove extremely stubborn dirt, like oil burnt onto the crankcase, with a degreasing agent and a brush, but never apply such products onto seals, gaskets and wheel axles. Always rinse the dirt and degreaser off with water.

Cleaning

ECA00011

CAUTION:

- **Avoid using strong acidic wheel cleaners, especially on spoked wheels. If such products are used on hard-to-remove dirt, do not leave the cleaner on the affected area any longer than instructed. Also, thoroughly rinse the area off with water, immediately dry it, and then apply a corrosion protection spray.**
- **Improper cleaning can damage windshields, cowlings, panels and other plastic parts. Use only a soft, clean cloth or sponge with mild detergent and water to clean plastic.**
- **Do not use any harsh chemical products on plastic parts. Be sure to avoid using cloths or sponges which have been in contact with strong or abrasive cleaning products, solvent or thinner, fuel (gasoline), rust removers or inhibitors, brake fluid, antifreeze or electrolyte.**

SCOOTER CARE AND STORAGE

- **Do not use high-pressure washers or steam-jet cleaners since they cause water seepage and deterioration in the following areas: seals (of wheel and swingarm bearings, fork and brakes), electric components (couplers, connectors, instruments, switches and lights), breather hoses and vents.**
 - **For scooters equipped with a windshield: Do not use strong cleaners or hard sponges as they will cause dulling or scratching. Some cleaning compounds for plastic may leave scratches on the windshield. Test the product on a small hidden part of the windshield to make sure that it does not leave any marks. If the windshield is scratched, use a quality plastic polishing compound after washing.**
-

After normal use

Remove dirt with warm water, a mild detergent, and a soft, clean sponge, and then rinse thoroughly with clean water. Use a toothbrush or bottlebrush for hard-to-reach areas. Stubborn dirt and insects will come off more easily if the area is covered with a wet cloth for a few minutes before cleaning.

After riding in the rain, near the sea or on salt-sprayed roads

Since sea salt or salt sprayed on the roads during winter are extremely corrosive in combination with water, carry out the following steps after each ride in the rain, near the sea or on salt-sprayed roads.

NOTE : _____

Salt sprayed on roads in the winter may remain well into spring.

1. Clean the scooter with cold water and a mild detergent after the engine has cooled down.

ECA00012

CAUTION: _____

Do not use warm water since it increases the corrosive action of the salt.

2. Apply a corrosion protection spray on all metal, including chrome- and nickel-plated, surfaces to prevent corrosion.

SCOOTER CARE AND STORAGE

After cleaning

1. Dry the scooter with a chamois or an absorbing cloth.
2. Use a chrome polish to shine chrome, aluminum and stainless-steel parts, including the exhaust system. (Even the thermally induced discoloring of stainless-steel exhaust systems can be removed through polishing.)
3. To prevent corrosion, it is recommended to apply a corrosion protection spray on all metal, including chrome- and nickel-plated, surfaces.
4. Use spray oil as a universal cleaner to remove any remaining dirt.
5. Touch up minor paint damage caused by stones, etc.
6. Wax all painted surfaces.
7. Let the scooter dry completely before storing or covering it.

⚠ WARNING

EWA00002

- **Make sure that there is no oil or wax on the brakes or tires. If necessary, clean the brake discs and brake linings with a regular brake disc cleaner or acetone, and wash the tires with warm water and a mild detergent.**
 - **Before operating the scooter test its braking performance and cornering behavior.**
-

CAUTION:

ECA00013

- **Apply spray oil and wax sparingly and make sure to wipe off any excess.**
 - **Never apply oil or wax to any rubber and plastic parts, but treat them with a suitable care product.**
 - **Avoid using abrasive polishing compounds as they will wear away the paint.**
-

NOTE :

Consult a Yamaha dealer for advice on what products to use.

SCOOTER CARE AND STORAGE

Storage

Short-term

Always store your scooter in a cool, dry place and, if necessary, protect it against dust with a porous cover.

CAUTION:

ECA00015

- **Storing the scooter in a poorly ventilated room or covering it with a tarp, while it is still wet, will allow water and humidity to seep in and cause rust.**
- **To prevent corrosion, avoid damp cellars, stables (because of the presence of ammonia) and areas where strong chemicals are stored.**

Long-term

Before storing your scooter for several months:

1. Follow all the instructions in the "Care" section of this chapter.
2. Drain the carburetor float chamber by loosening the drain bolt; this will prevent fuel deposits from building up. Pour the drained fuel into the fuel tank.
3. Fill up the fuel tank and add fuel stabilizer (if available) to prevent the fuel tank from rusting and the fuel from deteriorating.
4. Perform the following steps to protect the cylinder, piston rings, etc. from corrosion.
 - a. Remove the spark plug cap and spark plug.
 - b. Pour a teaspoonful of engine oil into the spark plug bore.
 - c. Install the spark plug cap onto the spark plug, and then place the spark plug on the cylinder head so that the electrodes are grounded. (This will limit sparking during the next step.)

- d. Turn the engine over several times with the starter. (This will coat the cylinder wall with oil.)
- e. Remove the spark plug cap from the spark plug, and then install the spark plug and the spark plug cap.

⚠ WARNING

EWA00003

To prevent damage or injury from sparking, make sure to ground the spark plug electrodes while turning the engine over.

5. Lubricate all control cables and the pivoting points of all levers and pedals as well as of the sidestand/centerstand.
6. Check and, if necessary, correct the tire air pressure, and then lift the scooter so that both of its wheels are off the ground. Alternatively, turn the wheels a little every month in order to prevent the tires from becoming degraded in one spot.

SCOOTER CARE AND STORAGE

7. Cover the muffler outlet with a plastic bag to prevent moisture from entering it.
8. Remove the battery and fully charge it. Store it in a cool, dry place and charge it once a month. Do not store the battery in an excessively cold or warm place (less than 0 °C or more than 30 °C). For more information on storing the battery, see page 6-19.

NOTE : _____

Make any necessary repairs before storing the scooter.

SPECIFICATIONS

Specifications 8-1
Conversion table 8-4

SPECIFICATIONS

Specifications

Model	EW50
Dimensions:	
Overall length	1,785 mm
Overall width	668 mm
Overall height	1,077 mm
Seat height	787 mm
Wheelbase	1,202 mm
Minimum ground clearance	185 mm
Minimum turning radius	1,800 mm
Weight:	
Wet (with oil and a full fuel tank)	81 kg
Engine:	
Engine type	Air cooled, 2strokes
Cylinder arrangement	Single cylinder, vertical
Displacement	49.2 cc
Bore x stroke	40.0 x 39.2 mm
Compression ratio	11.2:1
Starting system type	Electric and kick starter
Lubrication system	Separate lubrication (Autolube)
Engine oil:	
Type	Yamalube 2 or 2 strokes engine oil
Classification	Jaso FC or ISO EG-C, EG-D
Quantity	1.3 L

Final transmission oil:	
Type	SAE 10W30 type SE
Capacity	0.11L
Air filter type:	Wet type element
Fuel:	
Recommended fuel	Regular unleaded gasoline (RON 91 mini)
Fuel tank capacity	6.5 L
Carburetor:	
Type/quantity	TK ø12
Manufacturer	TEIKEI
Spark plug:	
Type / Manufacturer	BR8HS / NGK or BR9HS/NGK
Spark plug gap	0.5—0.7 mm
Clutch type:	Dry, centrifugal automatic
Transmission:	
Primary reduction system	Helical gear
Primary reduction ratio	52/13 (4.000)
Secondary reduction system	Spur gear
Secondary reduction ratio	42/13 (3.230)
Transmission type	V-belt automatic
Operation	Centrifugal automatic type
Chassis:	
Frame type	Steel tube underbone
Caster angle	27°
Trail	90 mm

Tires:

Front:

Type	Tubeless
Size / Manufacturer / model	120/80-12 55L / MICHELIN / BOPPER
	120/80-12 55J / CHENG SHIN / MAXXIS

Rear:

Type	Tubeless
Size / Manufacturer / model	130/90-10 61L / MICHELIN / BOPPER
	130/90-10 61J / CHENG SHIN / MAXXIS

Maximum load * 184 kg

Air pressure (cold tire):

Up to 90 kg load*	
Front	150 kPa (1,5 kgf/cm ² , 1,5 bar)
Rear	150 kPa (1,5 kgf/cm ² , 1,5 bar)
90 kg load—maximum load *	
Front	150 kPa (1,5 kgf/cm ² , 1,5 bar)
Rear	170 kPa (1,7 kgf/cm ² , 1,7 bar)

* Total weight of rider, passenger, cargo and accessories

Minimum tire tread depth 1.6 mm

Wheels:

Front

Type	Cast wheel/Aluminium
Size	12 X MT 2.75

Rear

Type	Cast wheel/aluminium
Size	10 X MT 3.00

Brakes:

Front

Type	Single disc brake
Operation	Right hand operation
Type brake fluid	DOT 4 or DOT 3

Rear

Type	Drum brake
Operation	Left hand operation

Suspension:

Front suspension	Telescopic fork
Rear suspension	Unit swing

Shock absorber:

Front fork type	Coil spring/oil damper
Rear shock absorber assembly type	Coil spring/oil damper

Wheel travel:

Front wheel travel	104 mm
Rear wheel travel	100 mm

SPECIFICATIONS

Electrical:

Ignition system type	C.D.I
Charging system	Flywheel magneto
Battery	Model GM4-3B, YB4L-B, FB4-B
Voltage/capacity	12 V / 4 Ah

Headlight type:

Bulb

Bulbs (voltage/wattage x quantity):

Headlight	12V, 35W/35Wx1
Tail/brake light	12V, 5W/21Wx1
Turn signal light	
Front	12V, 10Wx2
Rear	12V, 10Wx2
Meter lights	12V, 1.2Wx2
High beam indicator light	12V, 2Wx1
Turn signal indicator light	12V, 2Wx1
Oil level warning light	12V, 2Wx1
Fuel level warning light	12V, 2Wx1

Fuses:

Main fuse	7A
-----------	----

Conversion table

All specification data in this manual are listed in SI and METRIC UNITS.

Use this table to convert METRIC unit values to IMPERIAL unit values.

Example:

METRIC VALUE	CONVERSION FACTOR	=	IMPERIAL VALUE
2 mm	0.03937	=	0.08 in

Conversion table

METRIC SYSTEM TO IMPERIAL SYSTEM			
	Metric unit	Conversion factor	Imperial unit
Torque	m•kgf	7.233	ft•lbf
	m•kgf	86.794	in•lbf
	cm•kgf	0.0723	ft•lbf
	cm•kgf	0.8679	in•lbf
Weight	kg	2.205	lb
	g	0.03527	oz
Speed	km/h	0.6214	mi/h
Distance	km	0.6214	mi
	m	3.281	ft
	m	1.094	yd
	cm	0.3937	in
	mm	0.03937	in
Volume, Capacity	cc (cm ³)	0.03527	oz (IMP liq.)
	cc (cm ³)	0.06102	cu•in
	L (liter)	0.8799	qt (IMP liq.)
	L (liter)	0.2199	gal (IMP liq.)
Miscellaneous	kg/mm	55.997	lb/in
	kgf/cm ²	14.2234	psi (lbf/in ²)
	°C	1.8 + 32	°F

CONSUMER INFORMATION

Identification numbers 9-1
Key identification number 9-1
Vehicle identification number 9-1
Model label 9-2

CONSUMER INFORMATION

EAU02944

Identification numbers

Record the key identification number, vehicle identification number and model label information in the spaces provided below for assistance when ordering spare parts from a Yamaha dealer or for reference in case the vehicle is stolen.

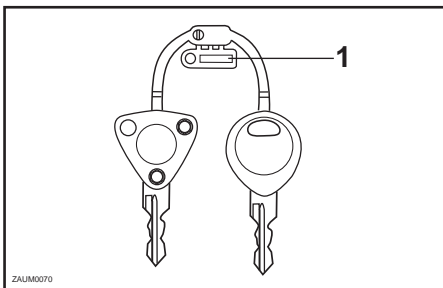

1. Key identification number

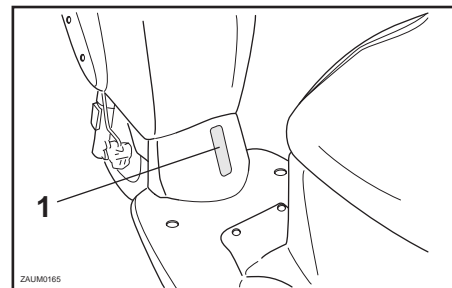

1. Vehicle identification number

1. KEY IDENTIFICATION NUMBER:

2. VEHICLE IDENTIFICATION NUMBER:

3. MODEL LABEL INFORMATION:

EAU01041

Key identification number

The key identification number is stamped into the key tag.

Record this number in the space provided and use it for reference when ordering a new key.

EAU01043

Vehicle identification number

The vehicle identification number is stamped into the steering head pipe.

Record this number in the space provided.

NOTE : _____

The vehicle identification number is used to identify your scooter and may be used to register your scooter with the licensing authority in your area.

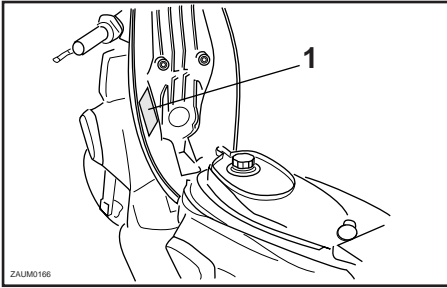

1. Model label

EAU01278

Model label

The model label is affixed to the bottom of the seat. (See page 3-8 for seat opening procedures.) Record the information on this label in the space provided. This information will be needed when ordering spare parts from a Yamaha dealer.



PRINTED IN FRANCE
2003.01 (E)