



- ⚠ Read this manual carefully before operating this vehicle.
- ⚠ Il convient de lire attentivement ce manuel avant la première utilisation du véhicule.
- ⚠ Bitte lesen Sie diese Bedienungsanleitung sorgfältig durch, bevor Sie das Fahrzeug in Betrieb nehmen.

**OWNER'S MANUAL
MANUEL DU PROPRIÉTAIRE
BEDIENUNGSANLEITUNG**

PW

80

PW80(Z)

3RV-28199-8K

PRINTED ON RECYCLED PAPER
IMPRIMÉ SUR PAPIER RECYCLÉ
AUF RECYCLINGPAPIER GEDRUCKT



PRINTED IN JAPAN
2009.04-0.2×1 
(E, F, G)



 Read this manual carefully before operating this vehicle.

OWNER'S MANUAL

PW

80

PW80(Z)

3RV-28199-8K-E0

 **Read this manual carefully before operating this vehicle. This manual should stay with this vehicle if it is sold.**

EC Declaration of Conformity

conforming to Directive 98/ 37/EC, 2006/42/EC

We, YAMAHA MOTOR CO., LTD. 2500 Shingai, Iwata, Japan,
declare in sole responsibility, that the product

PW80 (JYA4BC00000109301-)

(Make, model)

to which this declaration applies, conforms to the essential health
and safety requirements of Directive 98/ 37/EC, 2006/42/EC

(If applicable)

and to the other relevant Directives of EEC

2004/108/EC

(Title and/or number and date of issue of the other Directives of EEC)

(If applicable)

To effect correct application of the essential health and safety requirements
stated in the Directives of EEC, the following-standards and/or technical
specifications were consulted:

--

(Title and/or number and date of issue of standards and/or specifications)

Authorized Representative

YAMAHA MOTOR EUROPE N.V.

Koolhovenlaan 101,1119 NC Schiphol-Rijk,The Netherlands

Signature



Kunihiko Miwa

Division Manager

Motorcycle Headquarters

Product Development Operations

Date of Issue 27 February, 2009

Congratulations on your purchase of the Yamaha PW80(Z). This model is the result of Yamaha's vast experience in the production of fine sporting, touring, and pacesetter racing machines. It represents the high degree of craftsmanship and reliability that have made Yamaha a leader in these fields.

This manual will give you an understanding of the operation, inspection, and basic maintenance of this motorcycle. If you have any questions concerning the operation or maintenance of your motorcycle, please consult a Yamaha dealer.

The design and manufacture of this Yamaha motorcycle fully comply with the emissions standards for clean air applicable at the date of manufacture. Yamaha has met these standards without reducing the performance or economy of operation of the motorcycle. To maintain these high standards, it is important that you and your Yamaha dealer pay close attention to the recommended maintenance schedules and operating instructions contained within this manual.

Yamaha continually seeks advancements in product design and quality. Therefore, while this manual contains the most current product information available at the time of printing, there may be minor discrepancies between your motorcycle and this manual. If there is any question concerning this manual, please consult a Yamaha dealer.

EWA10031

 WARNING

Please read this manual carefully and completely before operating this motorcycle.

EWA14351

 WARNING

This motorcycle is designed and manufactured for off-road use only. It is illegal to operate this motorcycle on any public street, road or highway. Such use is prohibited by law. This motorcycle complies with almost all state off-highway noise level and spark arrester laws and regulations. Please check your local riding laws and regulations before operating this motorcycle.

AN IMPORTANT SAFETY MESSAGE:

- Read this manual carefully and completely before operating this motorcycle. Make sure you understand all instructions.
- Pay close attention to the warning and notice labels on the motorcycle.
- Never operate a motorcycle without proper training or instruction.
- Weight of the rider should not exceed 40 kg (88 lb).

INTRODUCTION

AN IMPORTANT NOTE TO PARENTS:

This motorcycle is not a toy. Before you let your child ride this motorcycle, you should understand the instructions and warnings in this Owner's Manual. Then be sure your child understands and will follow them. Children differ in skills, physical abilities, and judgment. Some children may not be able to operate a motorcycle safely. Parents should supervise their child's use of the motorcycle at all times. Parents should permit continued use only if they determine that the child has the ability to operate the motorcycle safely.

Your motorcycle was delivered with a removable power reduction plate. Yamaha recommends that all beginners start off with the power reduction plate installed to limit the engine power available while they learn. Parents should decide when to remove the power reduction plate from the motorcycle for more power as their youngster's riding skills improve. Once the rider can operate with skill at the top speed permitted by power reduction plate installed, the power reduction plate can be removed.

Motorcycles are single track vehicles. Their safe use and operation are dependent upon the use of proper riding techniques as well as the expertise of the operator. Every operator should know the following requirements before riding this motorcycle.



He or she should:

- Obtain thorough instructions from a competent source on all aspects of motorcycle operation.
- Observe the warnings and maintenance requirements in this Owner's Manual.
- Obtain qualified training in safe and proper riding techniques.
- Obtain professional technical service as indicated in this Owner's Manual and/or when made necessary by mechanical conditions.

IMPORTANT MANUAL INFORMATION

EAU10132

Particularly important information is distinguished in this manual by the following notations:

	This is the safety alert symbol. It is used to alert you to potential personal injury hazards. Obey all safety messages that follow this symbol to avoid possible injury or death.
	A WARNING indicates a hazardous situation which, if not avoided, could result in death or serious injury.
	A NOTICE indicates special precautions that must be taken to avoid damage to the vehicle or other property.
TIP	A TIP provides key information to make procedures easier or clearer.

IMPORTANT MANUAL INFORMATION

EAU10200

**PW80(Z)
OWNER'S MANUAL
©2009 by Yamaha Motor Co., Ltd.
1st edition, March 2009
All rights reserved.
Any reprinting or unauthorized use
without the written permission of
Yamaha Motor Co., Ltd.
is expressly prohibited.
Printed in Japan.**

TABLE OF CONTENTS

LOCATION OF IMPORTANT LABELS	1-1	OPERATION AND IMPORTANT RIDING POINTS	6-1	Checking the front and rear brake shoes	7-15
SAFETY INFORMATION	2-1	Starting and warming up a cold engine	6-1	Drive chain slack	7-16
DESCRIPTION	3-1	Starting a warm engine	6-2	Cleaning and lubricating the drive chain	7-17
Left view	3-1	Shifting	6-2	Checking and lubricating the cables	7-18
Right view	3-2	Engine break-in	6-3	Checking and lubricating the throttle grip and cable	7-18
Controls and instruments	3-3	Parking	6-4	Adjusting the Autolube pump	7-18
INSTRUMENT AND CONTROL FUNCTIONS	4-1	PERIODIC MAINTENANCE AND ADJUSTMENT	7-1	Checking and lubricating the brake lever	7-19
Handlebar switch	4-1	Owner's tool kit	7-1	Checking and lubricating the brake pedal	7-19
Power reduction plate	4-1	Periodic maintenance and lubrication chart	7-2	Checking and lubricating the sidestand	7-19
Shift pedal	4-1	Checking the spark plug	7-5	Checking the front fork	7-20
Brake lever	4-2	Removing the power reduction plate	7-6	Checking the steering	7-20
Brake pedal	4-2	Transmission oil	7-7	Checking the wheel bearings	7-21
Fuel tank cap	4-2	Cleaning the air filter element	7-8	Supporting the motorcycle	7-21
Fuel	4-3	Cleaning the spark arrester	7-9	Front wheel	7-22
Fuel tank breather hose	4-4	Cleaning the spark arrester	7-9	Rear wheel	7-24
2-stroke engine oil	4-4	Adjusting the carburetor	7-10	Troubleshooting	7-26
Fuel cock	4-5	Adjusting the engine idling speed	7-10	Troubleshooting chart	7-27
Starter (choke) lever " ⌵ "	4-6	Adjusting the throttle cable free play	7-11	MOTORCYCLE CARE AND STORAGE	8-1
Kickstarter	4-6	Tires	7-12	Matte color caution	8-1
Seat	4-7	Spoke wheels	7-13	Care	8-1
Shock absorber assembly	4-7	Adjusting the brake lever free play	7-13	Storage	8-3
Sidestand	4-8	Adjusting the brake pedal free play	7-14		
FOR YOUR SAFETY – PRE-OPERATION CHECKS	5-1				

TABLE OF CONTENTS

SPECIFICATIONS 9-1

CONSUMER INFORMATION..... 10-1

 Identification numbers 10-1

LOCATION OF IMPORTANT LABELS

EAU48130

Read and understand all of the labels on your vehicle. They contain important information for safe and proper operation of your vehicle. Never remove any labels from your vehicle. If a label becomes difficult to read or comes off, a replacement label is available from your Yamaha dealer.

For Europe

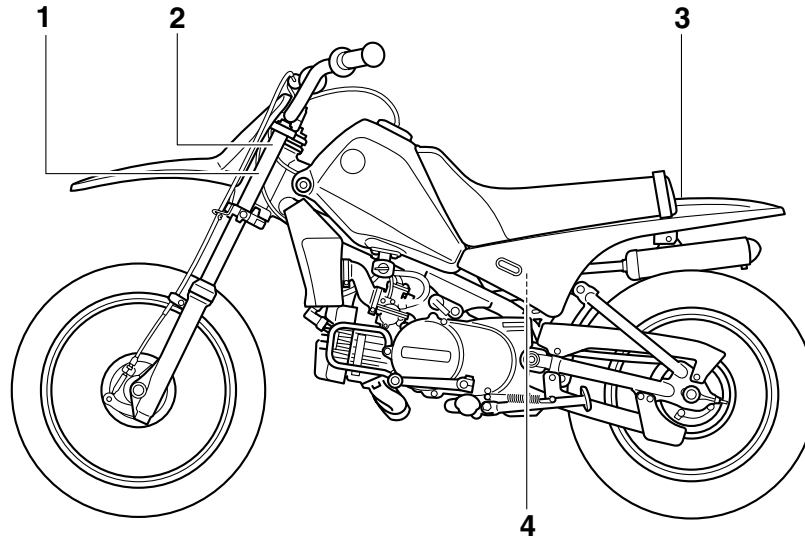

LOCATION OF IMPORTANT LABELS

For Europe





1

MODEL : PW80
MAX. POWER : 3.7 kW
MASS IN RUNNING ORDER : 61 kg
4BC-2156A-00

2

CE
YEAR OF CONSTRUCTION : 2009
YAMAHA MOTOR CO., LTD.
2500 SHINGAI, IWATA, JAPAN
5PG-2817L-10

3





100 kPa 100 kPa
1.00 kgf/cm² 1.00 kgf/cm²
15 psi 15 psi
5PG-2816R-00

4



LOCATION OF IMPORTANT LABELS

Familiarize yourself with the following pictograms and read the explanatory text.



Read the Owner's manual.



Use unleaded gasoline only.



This unit contains high-pressure nitrogen gas. Mishandling can cause explosion. Do not incinerate, puncture or open.



Measure tire pressure when tires are cold.



Turn off the main switch after riding to avoid draining the battery.



** kPa ** kPa
*** kgf/cm² *** kgf/cm²
** psi ** psi

Adjust tire pressure. Improper tire pressure can cause loss of control. Loss of control can result in severe injury or death.

LOCATION OF IMPORTANT LABELS

For Oceania and South Africa

1

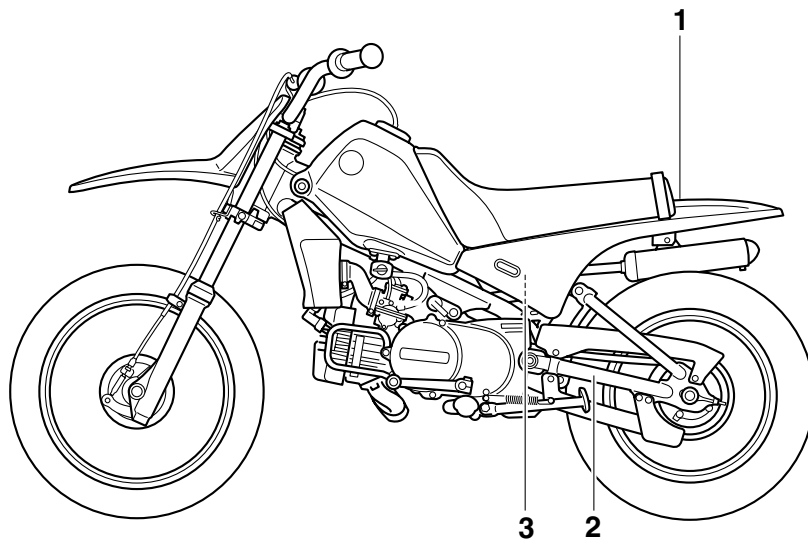

LOCATION OF IMPORTANT LABELS

For Oceania and South Africa

1

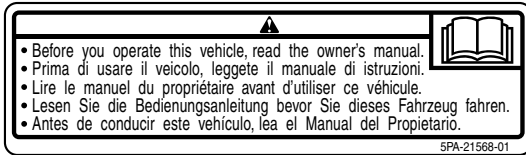

3



2

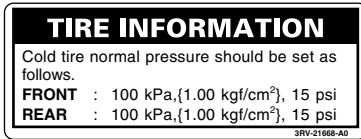

1

EAU41214

Be a Responsible Owner

As the vehicle's owner, you are responsible for the safe and proper operation of your motorcycle.

Motorcycles are single-track vehicles. Their safe use and operation are dependent upon the use of proper riding techniques as well as the expertise of the operator. Every operator should know the following requirements before riding this motorcycle.

He or she should:

- Obtain thorough instructions from a competent source on all aspects of motorcycle operation.
- Observe the warnings and maintenance requirements in this Owner's Manual.
- Obtain qualified training in safe and proper riding techniques.
- Obtain professional technical service as indicated in this Owner's Manual and/or when made necessary by mechanical conditions.

Safe Riding

Perform the pre-operation checks each time you use the vehicle to make sure it is in safe operating condition. Failure to inspect or maintain the vehicle properly increases the possibility of an accident or equipment damage. See page 5-1 for a list of pre-operation checks.

- This motorcycle is designed for off-road use only, therefore, it is illegal to operate it on public streets, roads, or highways, even a dirt or gravel one. Off-road use on public lands may be illegal. Please check local regulations before riding.
- This motorcycle is designed to carry the operator only. No passengers.
- The failure of motorists to detect and recognize motorcycles in traffic is the predominating cause of automobile/motorcycle accidents. Many accidents have been caused by an automobile driver who did not see the motorcycle. Making yourself conspicuous appears to be very effective in reducing the chance of this type of accident.

Therefore:

- Wear a brightly colored jacket.
- Use extra caution when you are approaching and passing through intersections, since intersections are the most likely places for motorcycle accidents to occur.
- Ride where other motorists can see you. Avoid riding in another motorist's blind spot.
- Many accidents involve inexperienced operators.
 - Make sure that you are qualified and that you only lend your motorcycle to other qualified operators.
 - Know your skills and limits. Staying within your limits may help you to avoid an accident.
 - We recommend that you practice riding your motorcycle until you have become thoroughly familiar with the motorcycle and all of its controls.
- Many accidents have been caused by error of the motorcycle operator. A typical error made by the op-

erator is veering wide on a turn due to excessive speed or undercornering (insufficient lean angle for the speed). Never travel faster than warranted by conditions.

- Ride cautiously in unfamiliar areas. You may encounter hidden obstacles that could cause an accident.
- The posture of the operator is important for proper control. The operator should keep both hands on the handlebar and both feet on the operator footrests during operation to maintain control of the motorcycle.
- Never ride under the influence of alcohol or other drugs.
- Be sure the transmission is in neutral before starting the engine.

Protective apparel

The majority of fatalities from motorcycle accidents are the result of head injuries. The use of a safety helmet is the single most critical factor in the prevention or reduction of head injuries.

- Always wear an approved helmet.

- Wear a face shield or goggles. Wind in your unprotected eyes could contribute to an impairment of vision that could delay seeing a hazard.
- The use of a jacket, heavy boots, trousers, gloves, etc., is effective in preventing or reducing abrasions or lacerations.
- Never wear loose-fitting clothes, otherwise they could catch on the control levers, footrests, or wheels and cause injury or an accident.
- Always wear protective clothing that covers your legs, ankles, and feet. The engine or exhaust system become very hot during or after operation and can cause burns.

Avoid Carbon Monoxide Poisoning

All engine exhaust contains carbon monoxide, a deadly gas. Breathing carbon monoxide can cause headaches, dizziness, drowsiness, nausea, confusion, and eventually death.

Carbon Monoxide is a colorless, odorless, tasteless gas which may be present even if you do not see or smell

any engine exhaust. Deadly levels of carbon monoxide can collect rapidly and you can quickly be overcome and unable to save yourself. Also, deadly levels of carbon monoxide can linger for hours or days in enclosed or poorly ventilated areas. If you experience any symptoms of carbon monoxide poisoning, leave the area immediately, get fresh air, and **SEEK MEDICAL TREATMENT.**

- Do not run engine indoors. Even if you try to ventilate engine exhaust with fans or open windows and doors, carbon monoxide can rapidly reach dangerous levels.
- Do not run engine in poorly ventilated or partially enclosed areas such as barns, garages, or carports.
- Do not run engine outdoors where engine exhaust can be drawn into a building through openings such as windows and doors.

Loading

Adding accessories to your motorcycle can adversely affect stability and han-

SAFETY INFORMATION

2

dling if the weight distribution of the motorcycle is changed. To avoid the possibility of an accident, use extreme caution when adding accessories to your motorcycle. Use extra care when riding a motorcycle that has added accessories. Here are some general guidelines to follow if adding accessories to your motorcycle:

Operation of an overloaded vehicle could cause an accident.

- The weight of the operator must not exceed 40.0 kg (88 lb).
- Accessory weight should be kept as low and close to the motorcycle as possible. Securely pack your heaviest items as close to the center of the vehicle as possible and make sure to distribute the weight as evenly as possible on both sides of the motorcycle to minimize imbalance or instability.
- Shifting weights can create a sudden imbalance. Make sure that accessories are securely attached to the motorcycle before riding. Check accessory mounts frequently.

- Properly adjust the suspension for your load, and check the condition and pressure of your tires.
- Never attach any large or heavy items to the handlebar, front fork, or front fender.

Genuine Yamaha Accessories

Choosing accessories for your vehicle is an important decision. Genuine Yamaha accessories, which are available only from a Yamaha dealer, have been designed, tested, and approved by Yamaha for use on your vehicle.

Many companies with no connection to Yamaha manufacture parts and accessories or offer other modifications for Yamaha vehicles. Yamaha is not in a position to test the products that these aftermarket companies produce. Therefore, Yamaha can neither endorse nor recommend the use of accessories not sold by Yamaha or modifications not specifically recommended by Yamaha, even if sold and installed by a Yamaha dealer.

Aftermarket Parts, Accessories, and Modifications

While you may find aftermarket products similar in design and quality to genuine Yamaha accessories, recognize that some aftermarket accessories or modifications are not suitable because of potential safety hazards to you or others. Installing aftermarket products or having other modifications performed to your vehicle that change any of the vehicle's design or operation characteristics can put you and others at greater risk of serious injury or death. You are responsible for injuries related to changes in the vehicle.

Keep the following guidelines in mind, as well as those provided under "Loading" when mounting accessories.

- Never install accessories that would impair the performance of your motorcycle. Carefully inspect the accessory before using it to make sure that it does not in any way reduce ground clearance or cornering clearance, limit suspension travel, steering travel or control operation.
- Accessories fitted to the handle-

bar or the front fork area can create instability due to improper weight distribution. If accessories are added to the handlebar or front fork area, they must be as lightweight as possible and should be kept to a minimum.

- Bulky or large accessories may seriously affect the stability of the motorcycle. Wind may attempt to lift the motorcycle, or the motorcycle may become unstable in cross winds.
- Certain accessories can displace the operator from his or her normal riding position. This improper position limits the freedom of movement of the operator and may limit control ability, therefore, such accessories are not recommended.
- Use caution when adding electrical accessories. If electrical accessories exceed the capacity of the motorcycle's electrical system, an electric failure could result, which could cause a dangerous loss of lights or engine power.

Aftermarket Tires and Rims

The tires and rims that came with your motorcycle were designed to match the performance capabilities and to provide the best combination of handling, braking, and comfort. Other tires, rims, sizes, and combinations may not be appropriate. Refer to page 7-12 for tire specifications and more information on replacing your tires.

DESCRIPTION

EAU10410

Left view

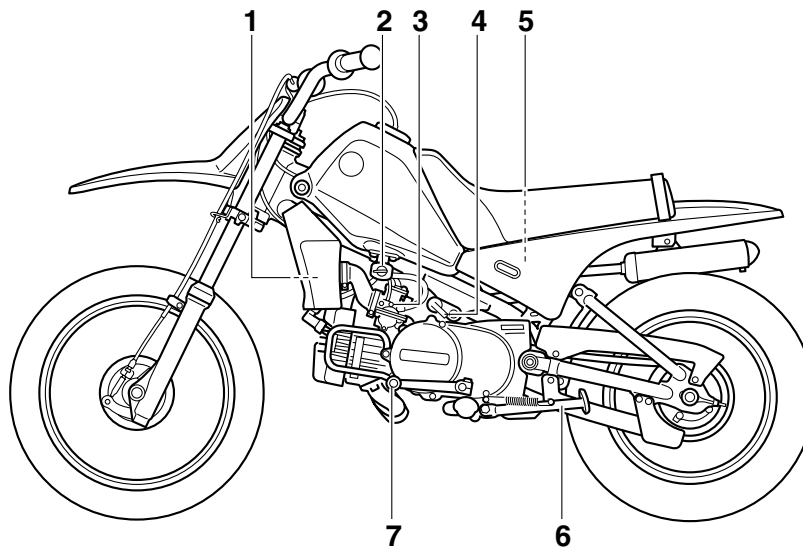

1. Air filter element (page 7-8)
2. Fuel cock (page 4-5)
3. Throttle stop screw (page 7-10)
4. Starter (choke) lever (page 4-6)
5. 2-stroke engine oil tank (page 4-4)
6. Sidestand (page 4-8)
7. Shift pedal (page 4-1)

Right view

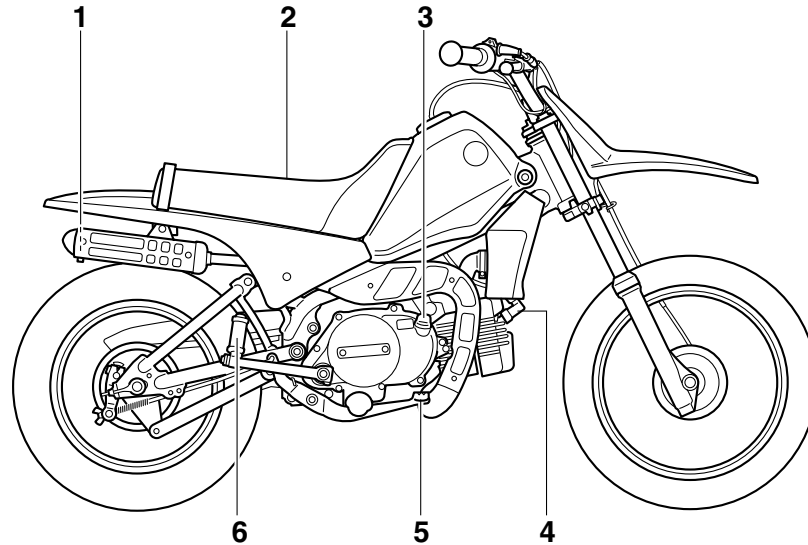

1. Spark arrester (page 7-9)
2. Seat (page 4-7)
3. Transmission oil filler cap (page 7-7)
4. Spark plug cap (page 7-5)
5. Brake pedal (page 4-2)
6. Kickstarter (page 4-6)

DESCRIPTION

EAU10430

Controls and instruments

3

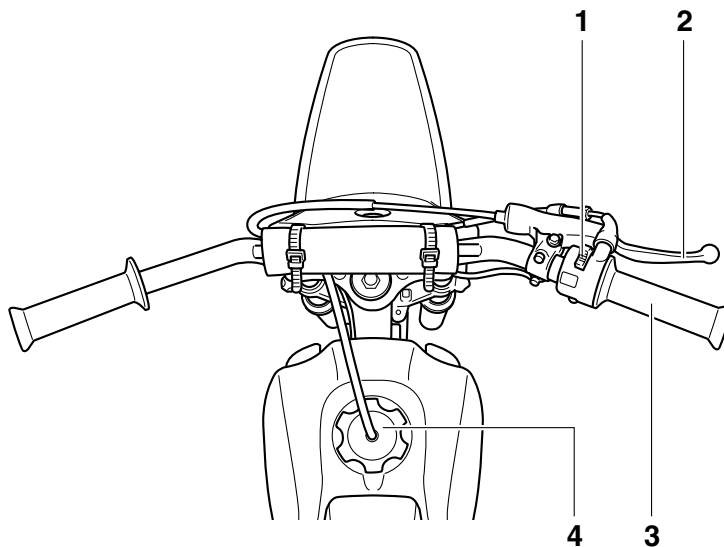

1. Handlebar switch (page 4-1)
2. Brake lever (page 4-2)
3. Throttle grip (page 7-11)
4. Fuel tank cap (page 4-2)

Handlebar switch

EAU40660

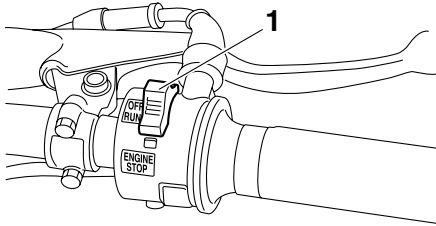

1. Engine stop switch "ENGINE STOP"

EAU41130

Engine stop switch "ENGINE STOP"

Set this switch to "RUN" before starting the engine. Set this switch to "OFF" to stop the engine.

Power reduction plate

EAU41590

Your motorcycle was delivered with a power reduction plate. Yamaha recommends that all beginning riders start off with the power reduction plate installed to limit the amount of power available while they learn.

Parents should decide when to adjust the motorcycle for more power as their youngster's riding skills improve. Once the rider can operate with skill at the top speed with the power reduction plate installed, the power reduction plate can be removed. (See page 7-6.)

Shift pedal

EAU39850

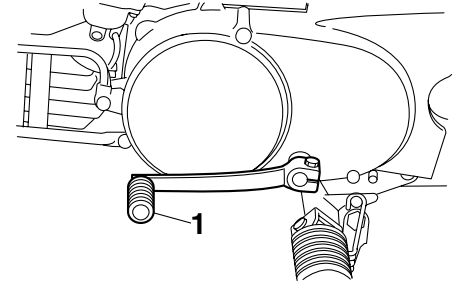

1. Shift pedal

This motorcycle is equipped with a constant-mesh 3-speed transmission. The shift pedal is located on the left side of the engine. Neutral is at the bottom position.

INSTRUMENT AND CONTROL FUNCTIONS

Brake lever

EAU12890

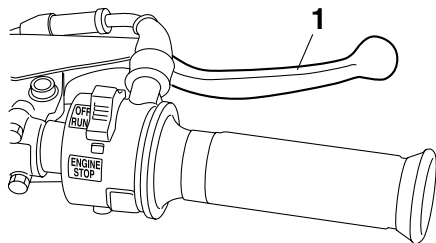

1. Brake lever

The brake lever is located at the right handlebar grip. To apply the front brake, pull the lever toward the handlebar grip.

Brake pedal

EAU12941

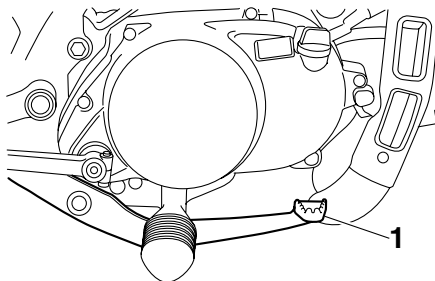

1. Brake pedal

The brake pedal is on the right side of the motorcycle. To apply the rear brake, press down on the brake pedal.

Fuel tank cap

EAU13182

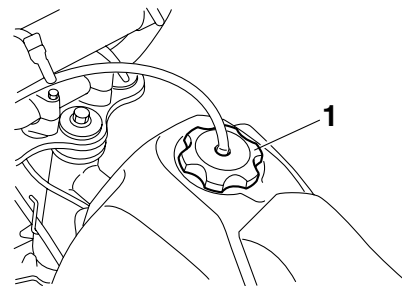

1. Fuel tank cap

To remove the fuel tank cap, turn it counterclockwise, and then pull it off. To install the fuel tank cap, insert it into the tank opening, and then turn it clockwise.

EWA11091

WARNING

Make sure that the fuel tank cap is properly closed after filling fuel. Leaking fuel is a fire hazard.

INSTRUMENT AND CONTROL FUNCTIONS

Fuel

Make sure there is sufficient gasoline in the tank.

EAU13221

EWA10881

WARNING

Gasoline and gasoline vapors are extremely flammable. To avoid fires and explosions and to reduce the risk of injury when refueling, follow these instructions.

1. Before refueling, turn off the engine and be sure that no one is sitting on the vehicle. Never refuel while smoking, or while in the vicinity of sparks, open flames, or other sources of ignition such as the pilot lights of water heaters and clothes dryers.
2. Do not overfill the fuel tank. When refueling, be sure to insert the pump nozzle into the fuel tank filler hole. Stop filling when the fuel reaches the bottom of the filler tube. Because fuel expands when it heats up, heat from the engine or the sun can cause fuel to spill out of the fuel tank.

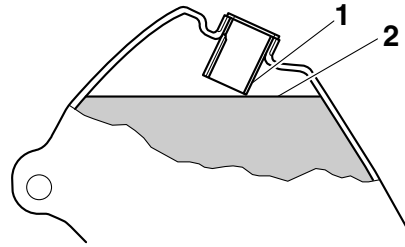

1. Fuel tank filler tube
2. Fuel level
3. Wipe up any spilled fuel immediately. **NOTICE: Immediately wipe off spilled fuel with a clean, dry, soft cloth, since fuel may deteriorate painted surfaces or plastic parts.**^[ECA10071]
4. Be sure to securely close the fuel tank cap.

EWA15151

WARNING

Gasoline is poisonous and can cause injury or death. Handle gasoline with care. Never siphon gasoline by mouth. If you should swallow some gasoline or inhale a lot of gasoline vapor, or get some gasoline in

your eyes, see your doctor immediately. If gasoline spills on your skin, wash with soap and water. If gasoline spills on your clothing, change your clothes.

EAU41960

Recommended fuel:

For Europe: REGULAR UNLEADED GASOLINE ONLY
Except for Europe: UNLEADED GASOLINE ONLY

Fuel tank capacity:

4.9 L (1.29 US gal, 1.08 Imp.gal)

Fuel reserve amount:

1.0 L (0.26 US gal, 0.22 Imp.gal)

ECA15590

NOTICE

Use only unleaded gasoline. The use of leaded gasoline will cause severe damage to internal engine parts, such as the piston rings as well as to the exhaust system.

Your Yamaha engine has been designed to use regular unleaded gasoline with a research octane number of 91 or higher. If knocking (or pinging) oc-

INSTRUMENT AND CONTROL FUNCTIONS

curs, use a gasoline of a different brand or premium unleaded fuel. Use of unleaded fuel will extend spark plug life and reduce maintenance costs.

Fuel tank breather hose

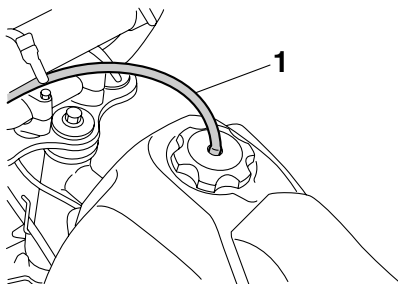

1. Fuel tank breather hose

Before operating the motorcycle:

- Check the fuel tank breather hose connection.
- Check the fuel tank breather hose for cracks or damage, and replace it if damaged.
- Make sure that the fuel tank breather hose is not blocked, and clean it if necessary.

EAU13412

2-stroke engine oil

Make sure that there is sufficient oil in the 2-stroke engine oil tank. If the 2-stroke engine oil is at or below the minimum level as shown in the illustration, add a sufficient amount of the recommended 2-stroke engine oil as follows.

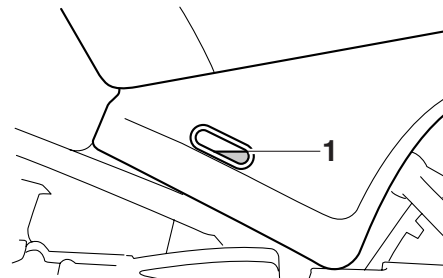

1. Minimum level

TIP

Make sure that the motorcycle is positioned straight up when checking the 2-stroke engine oil level. A slight tilt to the side can result in a false reading.

1. Remove the seat. (See page 4-7.)
2. Remove the 2-stroke engine oil

EAU41202

INSTRUMENT AND CONTROL FUNCTIONS

tank cap and add the recommended oil.

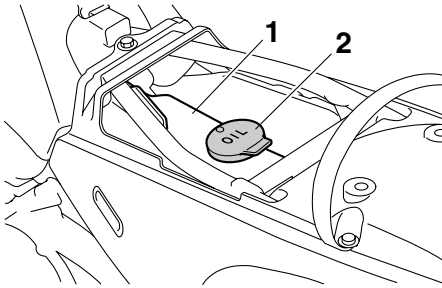

1. 2-stroke engine oil tank
2. 2-stroke engine oil tank cap

Recommended oil:

See page 9-1.

Oil quantity:

0.75 L (0.79 US qt, 0.66 Imp.qt)

3. Install the 2-stroke engine oil tank cap.

ECA16670

NOTICE

Make sure that the 2-stroke engine oil tank cap is properly installed.

4. Install the seat.

EAU13561

Fuel cock

The fuel cock supplies fuel from the tank to the carburetor while filtering it also.

The fuel cock has three positions:

OFF

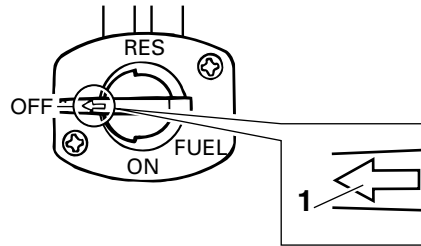

1. Arrow mark positioned over "OFF"

With the lever in this position, fuel will not flow. Always return the lever to this position when the engine is not running.

ON

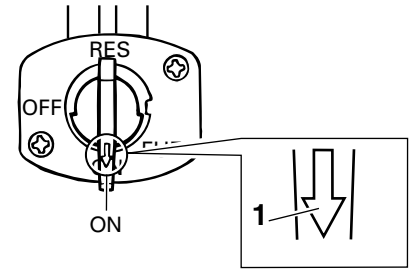

1. Arrow mark positioned over "ON"

With the lever in this position, fuel flows to the carburetor. Normal riding is done with the lever in this position.

RES

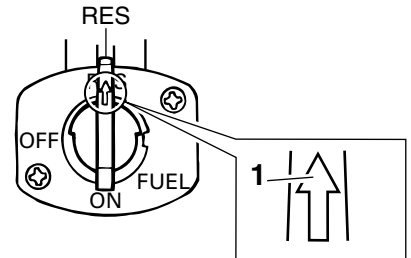

1. Arrow mark positioned over "RES"

INSTRUMENT AND CONTROL FUNCTIONS

This indicates reserve. If you run out of fuel while riding, move the lever to this position. Fill the tank at the first opportunity. Be sure to set the lever back to “ON” after refueling!

4

Starter (choke) lever “”

EAU13590

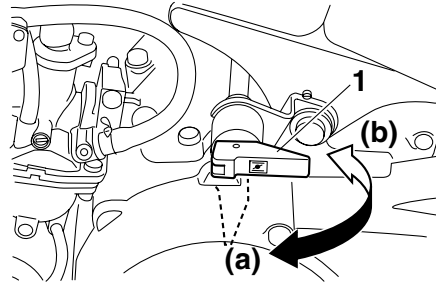

1. Starter (choke) lever “”

Starting a cold engine requires a richer air-fuel mixture, which is supplied by the starter (choke).

Move the lever in direction (a) to turn on the starter (choke).

Move the lever in direction (b) to turn off the starter (choke).

Kickstarter

EAU13680

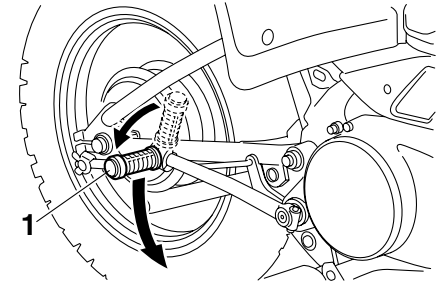

1. Kickstarter

To start the engine, fold out the kickstarter lever, move it down lightly with your foot until the gears engage, and then push it down smoothly but forcefully.

Seat

EAU41140

To remove the seat

Remove the nuts, and then pull the seat off.

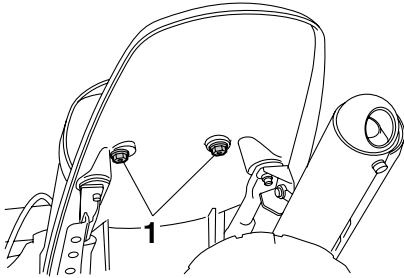

1. Nut

To install the seat

1. Insert the projection on the front of the seat into the seat holder as shown.

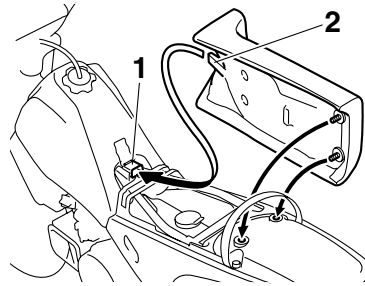

1. Seat holder
2. Projection

2. Place the seat in the original position, and then tighten the nuts.

TIP

Make sure that the seat is properly secured before riding.

Shock absorber assembly

EAU46021

EWA10221

⚠ WARNING

This shock absorber assembly contains highly pressurized nitrogen gas. Read and understand the following information before handling the shock absorber assembly.

- Do not tamper with or attempt to open the cylinder assembly.
- Do not subject the shock absorber assembly to an open flame or other high heat source. This may cause the unit to explode due to excessive gas pressure.
- Do not deform or damage the cylinder in any way. Cylinder damage will result in poor damping performance.
- Do not dispose of a damaged or worn-out shock absorber assembly yourself. Take the shock absorber assembly to a Yamaha dealer for any service.

INSTRUMENT AND CONTROL FUNCTIONS

EAU37490

Sidestand

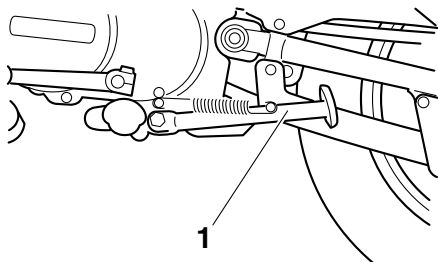

4

1. Sidestand

The sidestand is located on the left side of the frame. Raise the sidestand or lower it with your foot while holding the vehicle upright.

EWA14190

WARNING

The vehicle must not be ridden with the sidestand down, or if the sidestand cannot be properly moved up (or does not stay up), otherwise the sidestand could contact the ground and distract the operator, resulting in a possible loss of control.

FOR YOUR SAFETY – PRE-OPERATION CHECKS

EAU15596

Inspect your vehicle each time you use it to make sure the vehicle is in safe operating condition. Always follow the inspection and maintenance procedures and schedules described in the Owner's Manual.

EWA11151

WARNING

Failure to inspect or maintain the vehicle properly increases the possibility of an accident or equipment damage. Do not operate the vehicle if you find any problem. If a problem cannot be corrected by the procedures provided in this manual, have the vehicle inspected by a Yamaha dealer.

Before using this vehicle, check the following points:

ITEM	CHECKS	PAGE
Fuel	<ul style="list-style-type: none">• Check fuel level in fuel tank.• Refuel if necessary.• Check fuel line for leakage.	4-3
2-stroke engine oil	<ul style="list-style-type: none">• Check oil level in oil tank.• If necessary, add recommended oil to specified level.• Check vehicle for oil leakage.	4-4
Transmission oil	<ul style="list-style-type: none">• Check oil level in transmission case.• If necessary, add recommended oil to specified level.	7-7
Front brake	<ul style="list-style-type: none">• Check operation.• Lubricate cable if necessary.• Check lever free play.• Adjust if necessary.	7-13, 7-15
Rear brake	<ul style="list-style-type: none">• Check operation.• Check pedal free play.• Adjust if necessary.	7-14
Throttle grip	<ul style="list-style-type: none">• Make sure that operation is smooth.• Check cable free play.• If necessary, have Yamaha dealer adjust cable free play and lubricate cable and grip housing.	7-11, 7-18
Control cables	<ul style="list-style-type: none">• Make sure that operation is smooth.• Lubricate if necessary.	7-18

FOR YOUR SAFETY – PRE-OPERATION CHECKS

ITEM	CHECKS	PAGE
Drive chain	<ul style="list-style-type: none"> • Check chain slack. • Adjust if necessary. • Check chain condition. • Lubricate if necessary. 	7-16, 7-17
Wheels and tires	<ul style="list-style-type: none"> • Check for damage. • Check tire condition and tread depth. • Check air pressure. • Correct if necessary. 	7-12, 7-13
Shift pedal	<ul style="list-style-type: none"> • Make sure that operation is smooth. • Correct if necessary. 	—
Brake pedal	<ul style="list-style-type: none"> • Make sure that operation is smooth. • Lubricate pedal pivoting point if necessary. 	7-19
Brake lever	<ul style="list-style-type: none"> • Make sure that operation is smooth. • Lubricate lever pivoting point if necessary. 	7-19
Sidestand	<ul style="list-style-type: none"> • Make sure that operation is smooth. • Lubricate pivot if necessary. 	7-19
Chassis fasteners	<ul style="list-style-type: none"> • Make sure that all nuts, bolts and screws are properly tightened. • Tighten if necessary. 	—
Engine stop switch	<ul style="list-style-type: none"> • Check operation. 	4-1

OPERATION AND IMPORTANT RIDING POINTS

EAU15951

Read the Owner's Manual carefully to become familiar with all controls. If there is a control or function you do not understand, ask your Yamaha dealer.

EWA10271



Failure to familiarize yourself with the controls can lead to loss of control, which could cause an accident or injury.

EAU41155

Starting and warming up a cold engine

1. Turn the fuel cock lever to "ON".
2. Set the engine stop switch to "RUN".
3. Shift the transmission into the neutral position.

EWA14410



- Be sure to shift the transmission into neutral before starting the engine.
- Never ride with the sidestand down.

4. Turn the starter (choke) on and completely close the throttle. (See page 4-6.)
5. Start the engine by pushing the kickstarter lever down.
6. After starting the engine, move the starter (choke) back halfway.
NOTICE: For maximum engine life, never accelerate hard when the engine is cold!^[ECA11041]
7. When the engine is warm, turn the starter (choke) off.

TIP

The engine is warm when it responds normally to the throttle with the starter (choke) turned off.

OPERATION AND IMPORTANT RIDING POINTS

EAU16660

Starting a warm engine

Follow the same procedure as for starting a cold engine with the exception that the starter (choke) is not required when the engine is warm. Instead, start the engine with the throttle slightly open.

TIP

If the engine does not start after several kicks, try again with the throttle 1/4 to 1/2 open.

EAU39901

Shifting

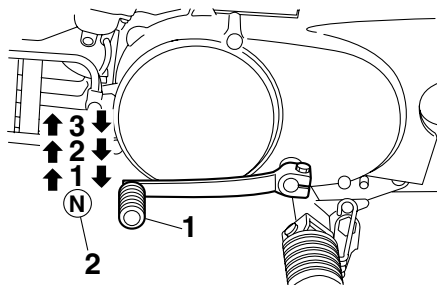

1. Shift pedal
2. Neutral position

This motorcycle has a 3-speed transmission with a centrifugal, automatic clutch. Shifting gears lets you control the amount of engine power available for starting off, accelerating, climbing hills, etc.

The gear positions are shown in the illustration.

TIP

To shift the transmission into the neutral position, press the shift pedal down repeatedly until it reaches the end of its travel.

ECA15441

NOTICE

- Even with the transmission in the neutral position, do not coast for long periods of time with the engine off, and do not tow the motorcycle for long distances. The transmission is properly lubricated only when the engine is running. Inadequate lubrication may damage the transmission.
- Always release the throttle grip before changing gears to avoid damaging the engine, transmission, and drive train, which are not designed to withstand the shock of shifting when the throttle grip is open.

EAU39911

To start out and accelerate

1. Close the throttle.
2. Shift into first gear and release the shift pedal. **NOTICE:** Always close the throttle before shifting gears, otherwise damage to the engine and drive train may result.^[ECA15461]

OPERATION AND IMPORTANT RIDING POINTS

3. Open the throttle gradually.
4. Once the motorcycle has reached a speed high enough to change gears, close the throttle.
5. Shift into second gear and release the shift pedal.
6. Open the throttle gradually.
7. Follow the same procedure when shifting to the next higher gear.

EAU16710

To decelerate

1. Close the throttle and apply both the front and the rear brakes to slow the motorcycle.
2. Downshift through the gears and shift the transmission into the neutral position when the motorcycle is almost completely stopped.

EAU39920

Engine break-in

There is never a more important period in the life of your engine than the first 5 hours of riding. It is also important to acustom the rider to the motorcycle during this time. Please read the following information carefully.

Since the engine is brand new, do not put an excessive load on it for the first 5 hours of operation. The various parts in the engine wear and polish themselves to the correct operating clearances. During this period, prolonged full-throttle operation or any condition that might result in engine overheating must be avoided. However, momentary full-throttle operation under load (i.e., two to three seconds maximum) does not harm the engine. Each full-throttle acceleration should be followed with a substantial rest period for the engine. To allow the engine to cool down from the temporary buildup of heat, cruise at a lower engine speed.

After the first 5 hours of operation, thoroughly check the motorcycle for loose parts, oil leakage and any other problems. Be sure to inspect and make ad-

justments thoroughly, especially cable and drive chain slack and loose spokes. In addition, check all fittings and fasteners for looseness, and tighten if necessary.

ECA10270

NOTICE

If any engine trouble should occur during the engine break-in period, immediately have a Yamaha dealer check the vehicle.

OPERATION AND IMPORTANT RIDING POINTS

EAU17191

Parking

When parking, stop the engine, and then turn the fuel cock lever to “OFF”.

EWA10311

WARNING

- Since the engine and exhaust system can become very hot, park in a place where pedestrians or children are not likely to touch them and be burned.
- Do not park on a slope or on soft ground, otherwise the vehicle may overturn, increasing the risk of a fuel leak and fire.
- Do not park near grass or other flammable materials which might catch fire.

PERIODIC MAINTENANCE AND ADJUSTMENT

EAU41951

Periodic inspection, adjustment, and lubrication will keep your vehicle in the safest and most efficient condition possible. Safety is an obligation of the vehicle owner/operator. The most important points of vehicle inspection, adjustment, and lubrication are explained on the following pages.

EWA10321

WARNING

Failure to properly maintain the vehicle or performing maintenance activities incorrectly may increase your risk of injury or death during service or while using the vehicle. If you are not familiar with vehicle service, have a Yamaha dealer perform service.

EWA15121

WARNING

Turn off the engine when performing maintenance unless otherwise specified.

- **A running engine has moving parts that can catch on body parts or clothing and electrical**

parts that can cause shocks or fires.

- **Running the engine while servicing can lead to eye injury, burns, fire, or carbon monoxide poisoning – possibly leading to death. See page 2-1 for more information about carbon monoxide.**

EAU17311

Owner's tool kit

The service information included in this manual and the tools provided in the owner's tool kit are intended to assist you in the performance of preventive maintenance and minor repairs. However, additional tools such as a torque wrench may be necessary to perform certain maintenance work correctly.

TIP

If you do not have the tools or experience required for a particular job, have a Yamaha dealer perform it for you.

PERIODIC MAINTENANCE AND ADJUSTMENT

EAU41765

Periodic maintenance and lubrication chart

TIP

- From 160 hours, repeat the maintenance intervals starting from 40 hours.
- Items marked with an asterisk should be performed by a Yamaha dealer as they require special tools, data and technical skills.

NO.	ITEM	CHECK OR MAINTENANCE JOB	INITIAL				THEREAFTER EVERY		
			10 hours	20 hours	40 hours	80 hours	40 hours	80 hours	160 hours
1	* Fuel line	<ul style="list-style-type: none"> ● Check fuel hoses for cracks or damage. ● Replace if necessary. 	√		√		√		
2	Spark plug	<ul style="list-style-type: none"> ● Check condition. ● Adjust gap and clean. ● Replace if necessary. 	√	√	√		√		
3	Air filter element	<ul style="list-style-type: none"> ● Clean with solvent. ● Replace if necessary. 		√	√	√	√		
4	* Clutch	<ul style="list-style-type: none"> ● Check operation. ● Adjust if necessary. 		√	√		√		
5	* Front brake	<ul style="list-style-type: none"> ● Check operation. ● Adjust brake lever free play. 		√	√		√		
		<ul style="list-style-type: none"> ● Replace brake shoes. 	Whenever worn to the limit						
6	* Rear brake	<ul style="list-style-type: none"> ● Check operation. ● Adjust brake pedal free play. 		√	√		√		
		<ul style="list-style-type: none"> ● Replace brake shoes. 	Whenever worn to the limit						
7	* Wheels	<ul style="list-style-type: none"> ● Check runout, spoke tightness and for damage. ● Tighten spokes if necessary. 	√	√	√		√		

7

PERIODIC MAINTENANCE AND ADJUSTMENT

NO.	ITEM	CHECK OR MAINTENANCE JOB	INITIAL				THEREAFTER EVERY			
			10 hours	20 hours	40 hours	80 hours	40 hours	80 hours	160 hours	
8	*	Tires	<ul style="list-style-type: none"> • Check tread depth and for damage. • Replace if necessary. • Check air pressure. • Correct if necessary. 	√	√	√		√		
9	*	Wheel bearings	<ul style="list-style-type: none"> • Check bearings for smooth operation. • Replace if necessary. 				√	√	√	
10	*	Steering bearings	<ul style="list-style-type: none"> • Check bearing assemblies for looseness. • Moderately repack with lithium-soap-based grease. 				√			√
11		Drive chain	<ul style="list-style-type: none"> • Check chain slack/alignment and condition. • Adjust and lubricate chain with Yamaha chain and cable lube thoroughly. 	Every ride						
			<ul style="list-style-type: none"> • Remove and clean. 			√		√		
12	*	Chassis fasteners	<ul style="list-style-type: none"> • Check all chassis fitting and fasteners. • Replace if necessary. 	√	√	√	√	√		
13		Sidestand pivot	<ul style="list-style-type: none"> • Check operation. • Apply lithium-soap-based grease lightly. 			√			√	
14	*	Front fork	<ul style="list-style-type: none"> • Check operation and for oil leakage. • Replace if necessary. 				√		√	
15	*	Shock absorber assembly	<ul style="list-style-type: none"> • Check operation and for oil leakage. • Replace if necessary. 				√		√	
16	*	Carburetor	<ul style="list-style-type: none"> • Check engine idling speed and starter operation. 		√	√	√		√	
			<ul style="list-style-type: none"> • Clean. • Replace if necessary. 							√

PERIODIC MAINTENANCE AND ADJUSTMENT

NO.	ITEM	CHECK OR MAINTENANCE JOB	INITIAL				THEREAFTER EVERY			
			10 hours	20 hours	40 hours	80 hours	40 hours	80 hours	160 hours	
17	*	Autolube pump	• Check operation. • Correct if necessary.	√	√	√		√		
18		Transmission oil	• Check for oil leakage. • Correct if necessary. • Change (warm engine before draining).		√	√			√	
19	*	Control cables	• Apply Yamaha chain and cable lube or engine oil 10W-30 lightly.			√	√		√	
20	*	Throttle grip housing and cable	• Check operation and free play. • Apply Yamaha chain and cable lube or engine oil 10W-30 lightly.	√	√	√		√		
21		Brake lever pivot shaft	• Apply lithium-soap-based grease lightly.			√			√	
22		Brake pedal pivot shaft	• Apply lithium-soap-based grease lightly.			√			√	
23	*	Cylinder head and exhaust system	• Check for leakage. • Tighten if necessary. • Decarbonize if necessary.			√			√	
24	*	Spark arrester	• Clean.			√		√		

7

TIP

The air filter needs more frequent service if you are riding in unusually wet or dusty areas.

PERIODIC MAINTENANCE AND ADJUSTMENT

EAU19603

Checking the spark plug

The spark plug is an important engine component, which is easy to check. Since heat and deposits will cause any spark plug to slowly erode, the spark plug should be removed and checked in accordance with the periodic maintenance and lubrication chart. In addition, the condition of the spark plug can reveal the condition of the engine.

To remove the spark plug

1. Remove the spark plug cap.

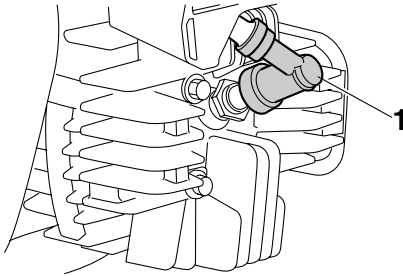

1. Spark plug cap

2. Remove the spark plug as shown, with the spark plug wrench included in the owner's tool kit.

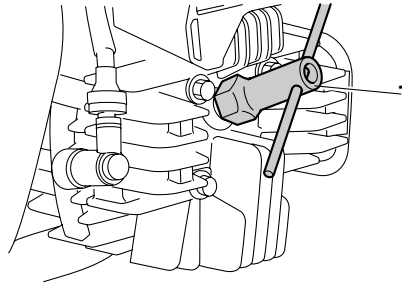

1. Spark plug wrench

To check the spark plug

1. Check that the porcelain insulator around the center electrode of the spark plug is a medium-to-light tan (the ideal color when the vehicle is ridden normally).

TIP

If the spark plug shows a distinctly different color, the engine could be operating improperly. Do not attempt to diagnose such problems yourself. Instead, have a Yamaha dealer check the vehicle.

2. Check the spark plug for electrode erosion and excessive carbon or other deposits, and replace

it if necessary.

Specified spark plug:

PW80 NGK/BPR6HS
PW80Z NGK/BP6HS
DENSO/W20FP

To install the spark plug

1. Measure the spark plug gap with a wire thickness gauge and, if necessary, adjust the gap to specification.

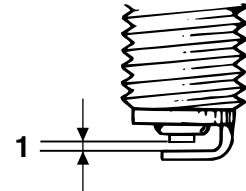

1. Spark plug gap

Spark plug gap:

0.6–0.7 mm (0.024–0.028 in)

2. Clean the surface of the spark plug gasket and its mating surface, and then wipe off any grime from the

PERIODIC MAINTENANCE AND ADJUSTMENT

spark plug threads.

3. Install the spark plug with the spark plug wrench, and then tighten it to the specified torque.

Tightening torque:

Spark plug:
25 Nm (2.5 m·kgf, 18.1 ft·lbf)

TIP

If a torque wrench is not available when installing a spark plug, a good estimate of the correct torque is 1/4–1/2 turn past finger tight. However, the spark plug should be tightened to the specified torque as soon as possible.

4. Install the spark plug cap.

7

Removing the power reduction plate

EAU41102

To obtain full engine performance capability, removing the power reduction plate is required.

1. Remove the exhaust manifold by removing the bolts. **WARNING! Always let the exhaust system cool prior to touching exhaust components.**^[EWA14581]

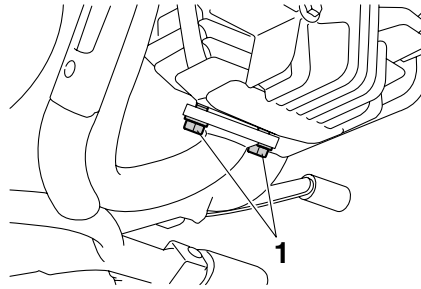

1. Exhaust manifold bolt
2. Remove the gasket.
3. Remove the power reduction plate.

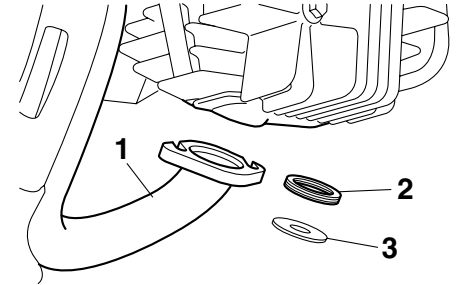

1. Exhaust manifold
2. Gasket
3. Power reduction plate

TIP

Store the power reduction plate with the Owner's Manual so that it is readily available whenever you want to reduce the engine power.

4. Install the exhaust manifold by installing the bolts.

Tightening torque:

Exhaust manifold bolt:
18 Nm (1.8 m·kgf, 13.0 ft·lbf)

PERIODIC MAINTENANCE AND ADJUSTMENT

EAU19943

Transmission oil

The transmission oil level should be checked before each ride. In addition, the transmission oil must be changed at the intervals specified in the periodic maintenance and lubrication chart.

To check the transmission oil level

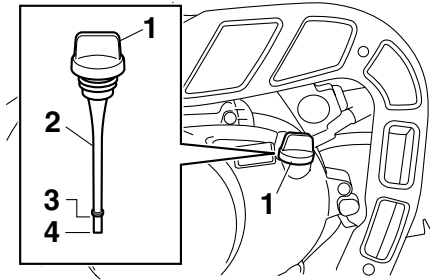

1. Transmission oil filler cap
2. Dipstick
3. Maximum level mark
4. Minimum level mark

1. Place the vehicle on a level surface and hold it in an upright position.

TIP

Make sure that the vehicle is positioned

straight up when checking the oil level. A slight tilt to the side can result in a false reading.

2. Wait a few minutes until the oil settles, remove the oil filler cap, wipe the dipstick clean, insert it back into the oil filler hole (without screwing it in), and then remove it again to check the oil level.

TIP

The transmission oil should be between the minimum and maximum level marks.

3. If the oil is below the minimum level mark, add sufficient oil of the recommended type to raise it to the correct level.
4. Insert the dipstick into the oil filler hole, and then tighten the oil filler cap.

To change the transmission oil

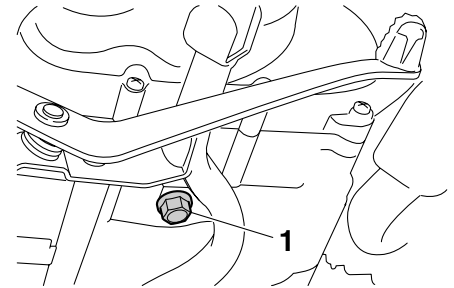

1. Transmission oil drain bolt

1. Place an oil pan under the transmission to collect the used oil.
2. Remove the oil filler cap and drain bolt to drain the oil from the transmission.
3. Install the transmission oil drain bolt, and then tighten it to the specified torque.

Tightening torque:

Transmission oil drain bolt:
20 Nm (2.0 m·kgf, 14.5 ft·lbf)

4. Refill with the specified amount of the recommended transmission oil, and then install and tighten the oil filler cap.

PERIODIC MAINTENANCE AND ADJUSTMENT

Recommended transmission oil:

See page 9-1.

Oil change quantity:

0.65 L (0.69 US qt, 0.57 Imp.qt)

ECA10452

NOTICE

- In order to prevent clutch slippage (since the transmission oil also lubricates the clutch), do not mix any chemical additives. Do not use oils with a diesel specification of “CD” or oils of a higher quality than specified. In addition, do not use oils labeled “ENERGY CONSERVING II” or higher.
- Make sure that no foreign material enters the transmission.

5. Start the engine, and then let it idle for several minutes while checking the transmission for oil leakage. If oil is leaking, immediately turn the engine off and check for the cause.

EAU41162

Cleaning the air filter element

The air filter element should be cleaned at the intervals specified in the periodic maintenance and lubrication chart. Clean the air filter element more frequently if you are riding in unusually wet or dusty areas.

1. Remove the air filter case cover by removing the screws.

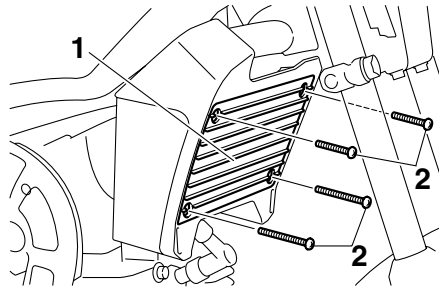

1. Air filter case cover
2. Screw

2. Pull the air filter element out.

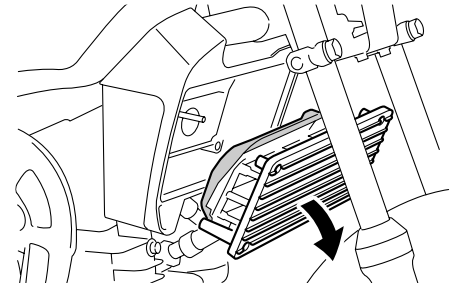

3. Remove the sponge material from the air filter case cover, clean it with solvent, and then squeeze the remaining solvent out.

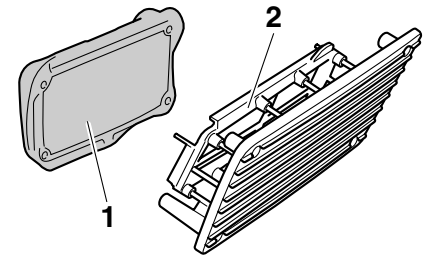

1. Sponge material
2. Air filter case cover

PERIODIC MAINTENANCE AND ADJUSTMENT

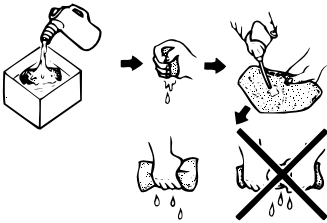

4. Apply oil of the recommended type to the entire surface of the sponge material, and then squeeze the excess oil out.

TIP

The sponge material should be wet but not dripping.

Recommended oil:

Yamaha foam air filter oil or other quality foam air filter oil

5. Install the sponge material onto the air filter case cover.
6. Insert the air filter element into the air filter case. **NOTICE: Make sure that the air filter element is properly seated in the air filter case. The engine should never be op-**

- erated without the air filter element installed, otherwise the piston(s) and/or cylinder(s) may become excessively worn.^[ECA10481]
7. Install the air filter case cover by installing the screws.

EAU41232

Cleaning the spark arrester

The spark arrester should be cleaned at the intervals specified in the periodic maintenance and lubrication chart.

EWA10980

WARNING

- Always let the exhaust system cool prior to touching exhaust components.
- Do not start the engine when cleaning the exhaust system.

1. Remove the tailpipe by removing the bolt, and then pulling it out of the muffler.

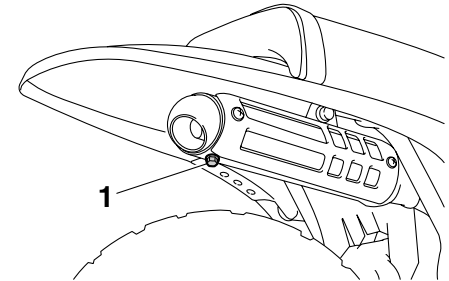

1. Bolt

2. Tap the tailpipe lightly, and then use a wire brush to remove any

PERIODIC MAINTENANCE AND ADJUSTMENT

carbon deposits from the spark arrester portion of the tailpipe and inside of the tailpipe housing.

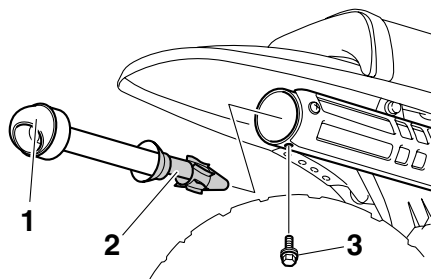

1. Tailpipe
2. Spark arrester
3. Bolt

3. Insert the tailpipe into the muffler, and then install and tighten the bolt to the specified torque.

Tightening torque:

Tailpipe bolt:
7.5 Nm (0.8 m-kgf, 5.5 ft-lbf)

TIP

Make sure to align the bolt hole when inserting the tailpipe.

EAU39930

Adjusting the carburetor

The carburetor is an important part of the engine and requires very sophisticated adjustment. Therefore, most carburetor adjustments should be left to a Yamaha dealer, who has the necessary professional knowledge and experience. The adjustment described in the following section, however, may be serviced by the owner as part of routine maintenance.

ECA10550

NOTICE

The carburetor has been set and extensively tested at the Yamaha factory. Changing these settings without sufficient technical knowledge may result in poor performance of or damage to the engine.

EAU21340

Adjusting the engine idling speed

The engine idling speed must be checked and, if necessary, adjusted as follows at the intervals specified in the periodic maintenance and lubrication chart.

The engine should be warm before making this adjustment.

TIP

- The engine is warm when it quickly responds to the throttle.
- A diagnostic tachometer is needed to make this adjustment.

1. Attach the tachometer to the spark plug lead.
2. Check the engine idling speed and, if necessary, adjust it to specification by turning the throttle stop screw. To increase the engine idling speed, turn the screw in direction (a). To decrease the engine idling speed, turn the screw in direction (b).

PERIODIC MAINTENANCE AND ADJUSTMENT

EAU21370

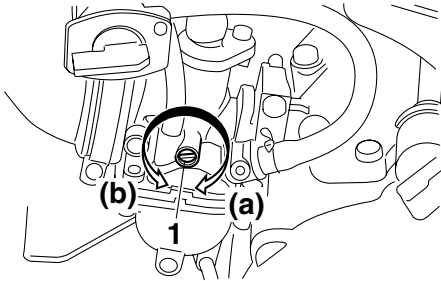

1. Throttle stop screw

Engine idling speed:
1650–1750 r/min

TIP

If the specified idling speed cannot be obtained as described above, have a Yamaha dealer make the adjustment.

Adjusting the throttle cable free play

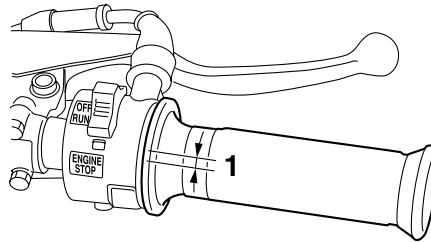

1. Throttle cable free play

The throttle cable free play should measure 3.0–5.0 mm (0.12–0.20 in) at the throttle grip. Periodically check the throttle cable free play and, if necessary, adjust it as follows.

TIP

The engine idling speed must be correctly adjusted before checking and adjusting the throttle cable free play.

1. Loosen the locknut.
2. To increase the throttle cable free play, turn the adjusting nut in direction (a). To decrease the throttle

cable free play, turn the adjusting nut in direction (b).

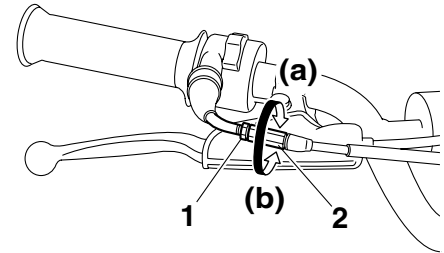

1. Locknut
2. Adjusting nut
3. Tighten the locknut.

PERIODIC MAINTENANCE AND ADJUSTMENT

Tires

To maximize the performance, durability, and safe operation of your motorcycle, note the following points regarding the specified tires.

EAU39821

Tire air pressure

The tire air pressure should be checked and, if necessary, adjusted before each ride.

EWA14381

WARNING

Operation of this vehicle with improper tire pressure may cause severe injury or death from loss of control.

- The tire air pressure must be checked and adjusted on cold tires (i.e., when the temperature of the tires equals the ambient temperature).
- The tire air pressure must be adjusted in accordance with the weight of the rider, the riding speed, and the riding conditions.

Standard tire air pressure:

Front:
100 kPa (1.00 kgf/cm², 15 psi)
Rear:
100 kPa (1.00 kgf/cm², 15 psi)

Tire inspection

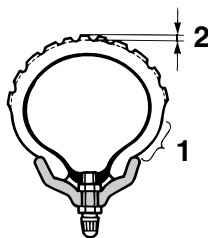

1. Tire sidewall
2. Tire tread depth

The tires must be checked before each ride. If the center tread depth reaches the specified limit, if the tire has a nail or glass fragments in it, or if the sidewall is cracked, have a Yamaha dealer replace the tire immediately.

Minimum tire tread depth (front and rear):

4.0 mm (0.16 in)

Tire information

This motorcycle is equipped with spoke wheels and tube tires.

EWA10461

WARNING

The front and rear tires should be of the same make and design, otherwise the handling characteristics of the vehicle may be different, which could lead to an accident.

After extensive tests, only the tires listed below have been approved for this model by Yamaha Motor Co., Ltd.

Front tire:

Size:
2.50-14 4PR
Manufacturer/model:
CHENG SHIN/KNOBBY

Rear tire:

Size:
3.00-12 4PR
Manufacturer/model:
CHENG SHIN/KNOBBY

EWA14390

WARNING

- Have a Yamaha dealer replace excessively worn tires. Operating the motorcycle with exces-

PERIODIC MAINTENANCE AND ADJUSTMENT

sively worn tires decreases riding stability and can lead to loss of control.

- The replacement of all wheel-and brake-related parts, including the tires, should be left to a Yamaha dealer, who has the necessary professional knowledge and experience.
- It is not recommended to patch a punctured tube. If unavoidable, however, patch the tube very carefully and replace it as soon as possible with a high-quality product.

Spoke wheels

To maximize the performance, durability, and safe operation of your motorcycle, note the following points regarding the specified wheels.

- The wheel rims should be checked for cracks, bends or warpage, and the spokes for looseness or damage before each ride. If any damage is found, have a Yamaha dealer replace the wheel. Do not attempt even the smallest repair to the wheel. A deformed or cracked wheel must be replaced.
- The wheel should be balanced whenever either the tire or wheel has been changed or replaced. An unbalanced wheel can result in poor performance, adverse handling characteristics, and a shortened tire life.
- Ride at moderate speeds after changing a tire since the tire surface must first be “broken in” for it to develop its optimal characteristics.

EAU21940

EAU22120

Adjusting the brake lever free play

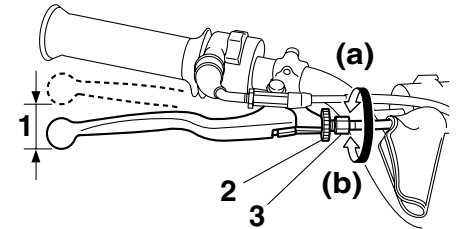

1. Brake lever free play
2. Locknut
3. Adjusting bolt

The brake lever free play should measure 10.0–20.0 mm (0.39–0.79 in) as shown. Periodically check the brake lever free play and, if necessary, adjust it as follows.

1. Loosen the locknut at the brake lever.
2. To increase the brake lever free play, turn the adjusting bolt in direction (a). To decrease the brake lever free play, turn the adjusting bolt in direction (b).

PERIODIC MAINTENANCE AND ADJUSTMENT

3. If the specified brake lever free play could be obtained as described above, tighten the locknut and skip the rest of the procedure, otherwise proceed as follows.
4. Fully turn the adjusting bolt at the brake lever in direction (a) to loosen the brake cable.
5. Loosen the locknut at the brake shoe plate.
6. To increase the brake lever free play, turn the adjusting nut in direction (a). To decrease the brake lever free play, turn the adjusting nut in direction (b).

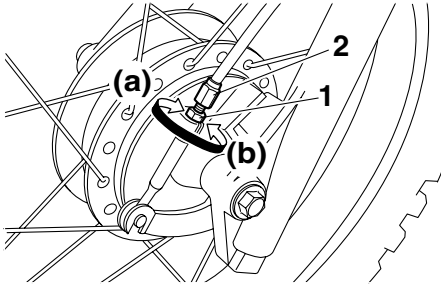

1. Locknut
2. Adjusting nut

7. Tighten the locknut at the brake

shoe plate and at the brake lever.

EAU39812

Adjusting the brake pedal free play

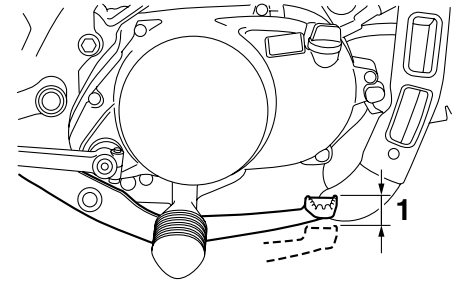

1. Brake pedal free play

The brake pedal free play should measure 10.0–20.0 mm (0.39–0.79 in) at the brake pedal end as shown. Periodically check the brake pedal free play and, if necessary, adjust it as follows.

To increase the brake pedal free play, turn the adjusting nut at the brake rod in direction (a). To decrease the brake pedal free play, turn the adjusting nut in direction (b).

PERIODIC MAINTENANCE AND ADJUSTMENT

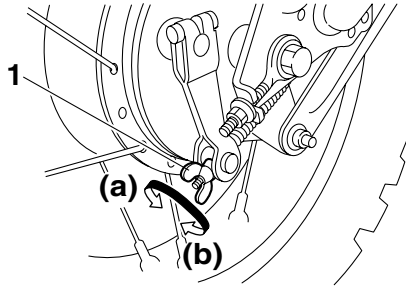

1. Brake pedal free play adjusting nut

EWA10680

WARNING

- After adjusting the drive chain slack or removing and installing the rear wheel, always check the brake pedal free play.
- If proper adjustment cannot be obtained as described, have a Yamaha dealer make this adjustment.
- After adjusting the brake pedal free play, check the operation of the brake light.

EAU41052

Checking the front and rear brake shoes

The front and rear brake shoes must be checked for wear at the intervals specified in the periodic maintenance and lubrication chart.

TIP

The wheels must be removed to check brake shoe lining thickness.

- To remove the front wheel: See page 7-22.
- To remove the rear wheel: See page 7-24.

Front

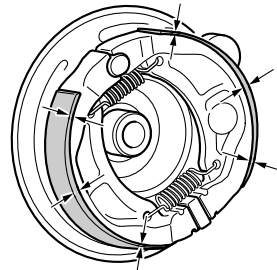

Rear

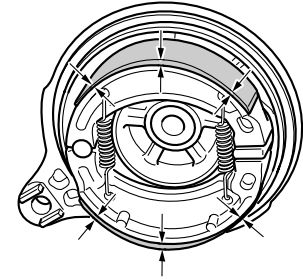

If the lining thickness of a brake shoe is less than 1.5 mm (0.06 in), have a Yamaha dealer replace the brake shoes as a set.

TIP

Be sure to measure the brake lining at the thinnest portion.

PERIODIC MAINTENANCE AND ADJUSTMENT

Drive chain slack

The drive chain slack should be checked before each ride and adjusted if necessary.

EAU22760

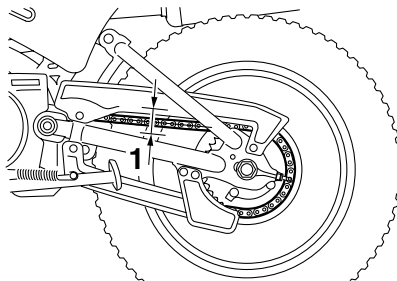

To check the drive chain slack

EAU22773

1. Place the motorcycle on the side-stand.

TIP

When checking and adjusting the drive chain slack, there should be no weight on the motorcycle.

2. Shift the transmission into the neutral position.
3. Move the rear wheel by pushing the motorcycle to locate the tightest portion of the drive chain, and then measure the drive chain slack as shown.

Drive chain slack:

40.0–53.0 mm (1.57–2.09 in)

1. Drive chain slack

4. If the drive chain slack is incorrect, adjust it as follows.

To adjust the drive chain slack

EAU40111

1. Loosen the brake pedal free play adjusting nut, axle nut, and locknut at each end of the swingarm.

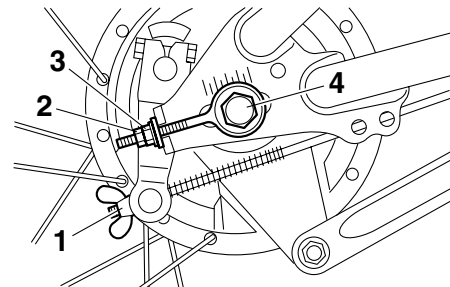

1. Brake pedal free play adjusting nut
2. Locknut
3. Drive chain slack adjusting nut
4. Wheel axle

2. To tighten the drive chain, turn the drive chain slack adjusting nut at each end of the swingarm in direction (a). To loosen the drive chain, turn the adjusting nut at each end of the swingarm in direction (b), and then push the rear wheel forward. **NOTICE: Improper drive chain slack will overload the engine as well as other vital parts of the motorcycle and can lead to chain slippage or breakage. To prevent this from occurring, keep the drive chain slack with-**

PERIODIC MAINTENANCE AND ADJUSTMENT

in the specified limits.^[ECA10571]

TIP

Using the alignment marks on each side of the swingarm, make sure that both adjusting nuts are in the same position for proper wheel alignment.

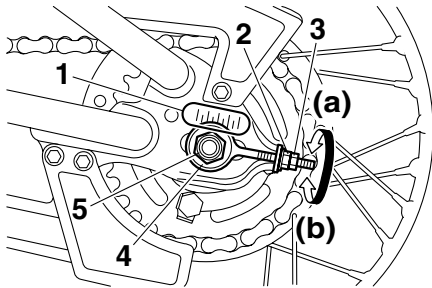

1. Alignment marks
 2. Drive chain slack adjusting nut
 3. Locknut
 4. Washer
 5. Axle nut
3. Tighten both locknuts and the axle nut to the specified torques.

Tightening torques:

Locknut:

6.5 Nm (0.7 m·kgf, 4.7 ft·lbf)

Axle nut:

60 Nm (6.0 m·kgf, 43.4 ft·lbf)

4. Adjust the brake pedal free play.
(See page 7-14.)

Cleaning and lubricating the drive chain

The drive chain must be cleaned and lubricated at the intervals specified in the periodic maintenance and lubrication chart, otherwise it will quickly wear out, especially when riding in dusty or wet areas. Service the drive chain as follows.

NOTICE

The drive chain must be lubricated after washing the motorcycle and riding in the rain.

1. Remove all dirt and mud from the drive chain with a brush or cloth.

TIP

For a thorough cleaning, have a Yamaha dealer remove the drive chain and soak it in solvent.

2. Spray Yamaha Chain and Cable Lube or a high-quality spray-type drive chain lubricant on both sides and on the middle of the chain, making sure that all side plates and rollers have been sufficiently oiled.

EAU23013

ECA10581

PERIODIC MAINTENANCE AND ADJUSTMENT

EAU41842

Checking and lubricating the cables

The operation of all control cables and the condition of the cables should be checked before each ride, and the cables and cable ends should be lubricated if necessary. If a cable is damaged or does not move smoothly, have a Yamaha dealer check or replace it.

WARNING! Damage to the outer housing of cables may result in internal rusting and cause interference with cable movement. Replace damaged cables as soon as possible to prevent unsafe conditions._[EWA10711]

EAU23111

Checking and lubricating the throttle grip and cable

The operation of the throttle grip should be checked before each ride. In addition, the cable should be lubricated at the intervals specified in the periodic maintenance chart.

EAU23120

Adjusting the Autolube pump

The Autolube pump is a vital and sophisticated component of the engine, which must be adjusted by a Yamaha dealer at the intervals specified in the periodic maintenance and lubrication chart.

7

Recommended lubricant:

Yamaha Chain and Cable Lube or
4-stroke engine oil

PERIODIC MAINTENANCE AND ADJUSTMENT

EAU43622

Checking and lubricating the brake lever

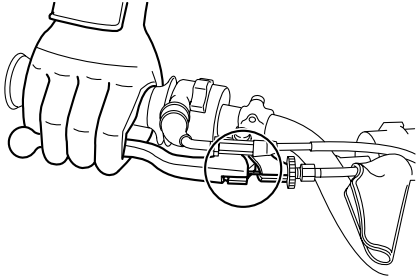

The operation of the brake lever should be checked before each ride, and the lever pivot should be lubricated if necessary.

Recommended lubricant:
Lithium-soap-based grease

EAU23182

Checking and lubricating the brake pedal

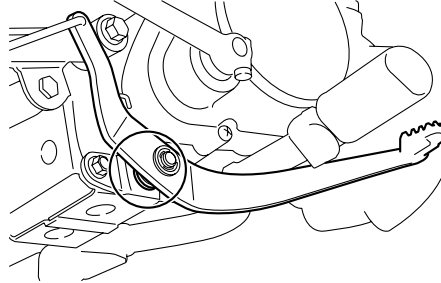

The operation of the brake pedal should be checked before each ride, and the pedal pivot should be lubricated if necessary.

Recommended lubricant:
Lithium-soap-based grease

EAU23202

Checking and lubricating the sidestand

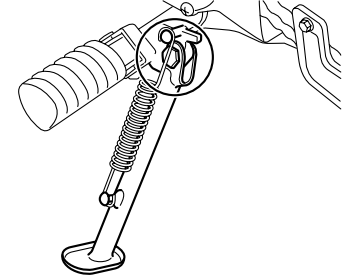

The operation of the sidestand should be checked before each ride, and the sidestand pivot and metal-to-metal contact surfaces should be lubricated if necessary.

EWA10731

⚠ WARNING

If the sidestand does not move up and down smoothly, have a Yamaha dealer check or repair it. Otherwise, the sidestand could contact the ground and distract the operator, resulting in a possible loss of control.

Recommended lubricant:
Lithium-soap-based grease

PERIODIC MAINTENANCE AND ADJUSTMENT

EAU23272

Checking the front fork

The condition and operation of the front fork must be checked as follows at the intervals specified in the periodic maintenance and lubrication chart.

To check the condition

Check the inner tubes for scratches, damage and excessive oil leakage.

To check the operation

1. Place the vehicle on a level surface and hold it in an upright position. **WARNING! To avoid injury, securely support the vehicle so there is no danger of it falling over.**^[EWA10751]
2. While applying the front brake, push down hard on the handlebars several times to check if the front fork compresses and rebounds smoothly.

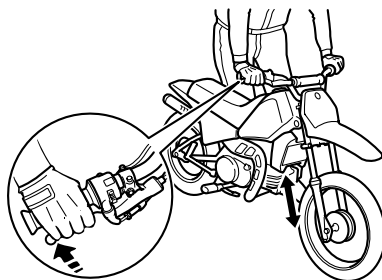

ECA10590

NOTICE

If any damage is found or the front fork does not operate smoothly, have a Yamaha dealer check or repair it.

EAU23283

Checking the steering

Worn or loose steering bearings may cause danger. Therefore, the operation of the steering must be checked as follows at the intervals specified in the periodic maintenance and lubrication chart.

1. Place a stand under the engine to raise the front wheel off the ground. (See page 7-21 for more information.) **WARNING! To avoid injury, securely support the vehicle so there is no danger of it falling over.**^[EWA10751]
2. Hold the lower ends of the front fork legs and try to move them forward and backward. If any free play can be felt, have a Yamaha dealer check or repair the steering.

PERIODIC MAINTENANCE AND ADJUSTMENT

EAU23290

EAU24350

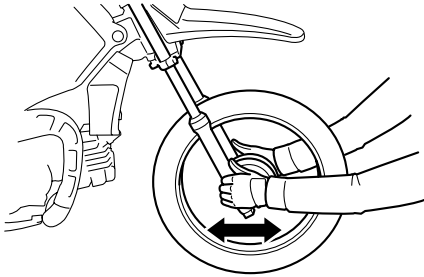

Checking the wheel bearings

The front and rear wheel bearings must be checked at the intervals specified in the periodic maintenance and lubrication chart. If there is play in the wheel hub or if the wheel does not turn smoothly, have a Yamaha dealer check the wheel bearings.

Supporting the motorcycle

Since this model is not equipped with a centerstand, follow these precautions when removing the front and rear wheel or performing other maintenance requiring the motorcycle to stand upright. Check that the motorcycle is in a stable and level position before starting any maintenance. A strong wooden box can be placed under the engine for added stability.

To service the front wheel

1. Stabilize the rear of the motorcycle by using a motorcycle stand or, if an additional motorcycle stand is not available, by placing a jack under the frame in front of the rear wheel.
2. Raise the front wheel off the ground by using a motorcycle stand.

To service the rear wheel

Raise the rear wheel off the ground by using a motorcycle stand or, if a motorcycle stand is not available, by placing a jack either under each side of the

PERIODIC MAINTENANCE AND ADJUSTMENT

frame in front of the rear wheel or under each side of the swingarm.

Front wheel

EAU24360

To remove the front wheel

EAU41532

EWA10821



WARNING

To avoid injury, securely support the vehicle so there is no danger of it falling over.

1. Remove the brake cable holder by removing the bolt.

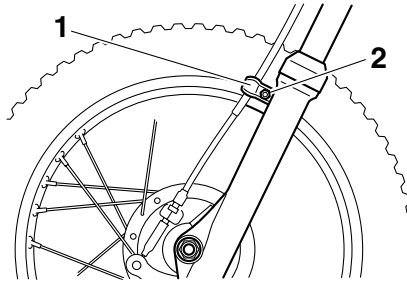

1. Brake cable holder
2. Bolt

2. Loosen the brake cable locknut at the front wheel hub, and then turn the brake cable free play adjusting bolt fully in direction (a).

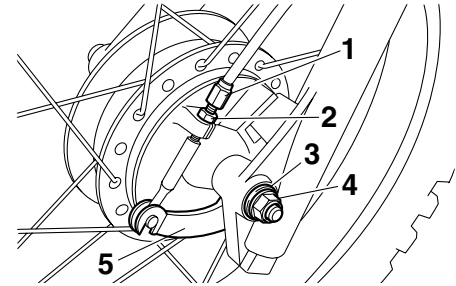

1. Adjusting nut
2. Locknut
3. Washer
4. Axle nut
5. Brake camshaft lever

3. Loosen the locknut at the brake lever, and then turn the adjusting bolt fully in direction (a).

PERIODIC MAINTENANCE AND ADJUSTMENT

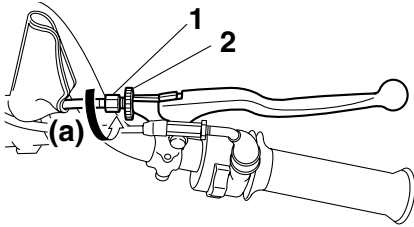

1. Adjusting bolt
2. Locknut
3. Disconnect the brake cable from the front brake lever.
4. Disconnect the brake cable from the brake camshaft lever.
5. Remove the brake cable free play adjusting bolt and the brake cable locknut at the front wheel hub.
6. Remove the axle nut and washer.
7. Remove the axle nut and washer.

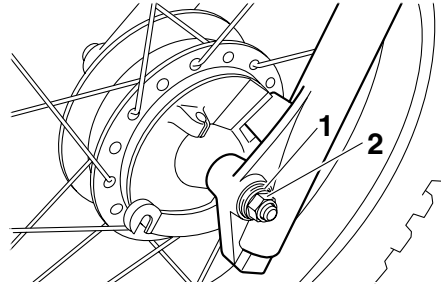

1. Washer
2. Axle nut
3. Lift the front wheel off the ground according to the procedure on page 7-21.
4. Pull the wheel axle out, and then remove the wheel.

EAU41550

To install the front wheel

1. Install the brake shoe plate into the wheel hub as shown.

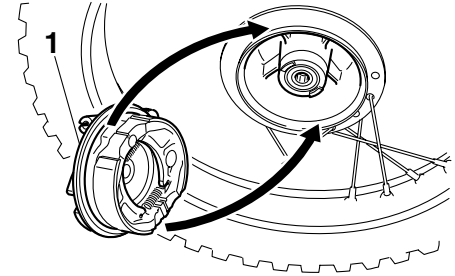

1. Brake shoe plate
2. Lift the wheel up between the fork legs.

TIP

Make sure that the slot in the brake shoe plate fits over the retainer on the fork leg.

PERIODIC MAINTENANCE AND ADJUSTMENT

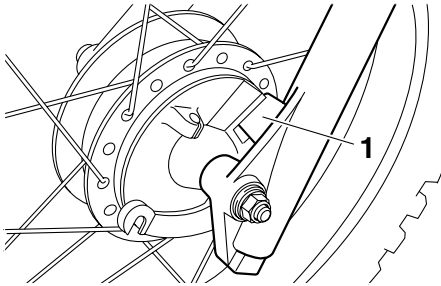

1. Retainer

3. Insert the wheel axle, and then install the washer and axle nut.
4. Lower the front wheel so that it is on the ground.
5. Connect the brake cable at the wheel hub.
6. Connect the brake cable at the front brake lever.
7. Install the brake cable holder by installing the bolt.
8. Tighten the axle nut to the specified torque.

Tightening torque:

Axle nut:

35 Nm (3.5 m-kgf, 25.3 ft-lbf)

9. Adjust the brake lever free play.

(See page 7-13.)

10. Push down hard on the handlebar several times to check for proper fork operation.

EAU25080

Rear wheel

EAU41562

To remove the rear wheel

EWA10821

! WARNING

To avoid injury, securely support the vehicle so there is no danger of it falling over.

1. Loosen the axle nut.

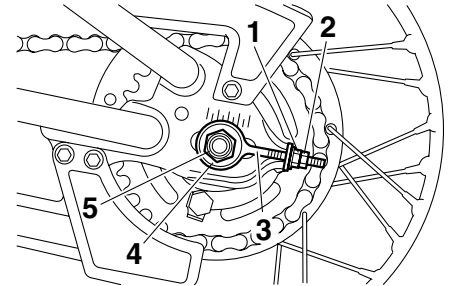

1. Drive chain slack adjusting nut
2. Locknut
3. Chain puller
4. Washer
5. Axle nut

2. Remove the brake pedal free play adjusting nut, and then disconnect

PERIODIC MAINTENANCE AND ADJUSTMENT

EAU41571

the brake rod from the brake camshaft lever.

3. Disconnect the brake torque rod from the brake shoe plate by removing the cotter pin, the nut, and the bolt.
4. Loosen the locknut and drive chain adjusting nut on each end of the swingarm.

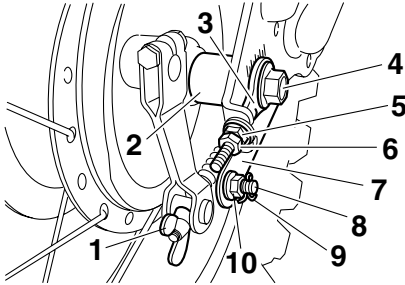

1. Brake pedal free play adjusting nut
2. Spacer
3. Chain puller
4. Wheel axle
5. Drive chain slack adjusting nut
6. Locknut
7. Brake torque rod
8. Brake torque rod bolt
9. Cotter pin
10. Brake torque rod nut

5. Lift the rear wheel off the ground according to the procedure on page 7-21.
6. Remove the axle nut and washer, and then pull the wheel axle out.
7. Push the wheel forward, and then remove the drive chain from the rear sprocket.

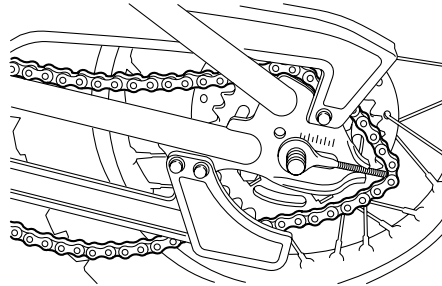

TIP

The drive chain does not need to be disassembled in order to remove and install the wheel.

8. Remove the spacer, chain pullers and wheel by pulling it back.

To install the rear wheel

1. Install the drive chain onto the rear sprocket.
2. Install the wheel by inserting the chain pullers, spacer and then insert the wheel axle from the right-hand side.
3. Install the brake rod onto the brake camshaft lever, and then install the brake pedal free play adjusting nut onto the brake rod.
4. Connect the brake torque rod onto the brake shoe plate by installing the bolt and nut, and then tighten the nut to the specified torque.

Tightening torque:

Brake torque rod nut:
15.5 Nm (1.6 m·kgf, 11.2 ft·lbf)

5. Insert a new cotter pin into the brake torque rod bolt. **WARNING! Always use a new cotter pin.**^[EWA10831]
6. Install the washer and axle nut, and then lower the rear wheel so that it is on the ground.
7. Adjust the drive chain slack. (See page 7-16.)

PERIODIC MAINTENANCE AND ADJUSTMENT

8. Tighten the axle nut to the specified torque.

Tightening torque:

Axle nut:

60 Nm (6.0 m·kgf, 43.4 ft·lbf)

9. Adjust the brake pedal free play. (See page 7-14.)

EAU25851

Troubleshooting

Although Yamaha motorcycles receive a thorough inspection before shipment from the factory, trouble may occur during operation. Any problem in the fuel, compression, or ignition systems, for example, can cause poor starting and loss of power.

The following troubleshooting chart represents a quick and easy procedure for checking these vital systems yourself. However, should your motorcycle require any repair, take it to a Yamaha dealer, whose skilled technicians have the necessary tools, experience, and know-how to service the motorcycle properly.

Use only genuine Yamaha replacement parts. Imitation parts may look like Yamaha parts, but they are often inferior, have a shorter service life and can lead to expensive repair bills.

EWA15141



When checking the fuel system, do not smoke, and make sure there are no open flames or sparks in the area, including pilot lights from water

heaters or furnaces. Gasoline or gasoline vapors can ignite or explode, causing severe injury or property damage.

PERIODIC MAINTENANCE AND ADJUSTMENT

EAU25972

Troubleshooting chart

1. Fuel

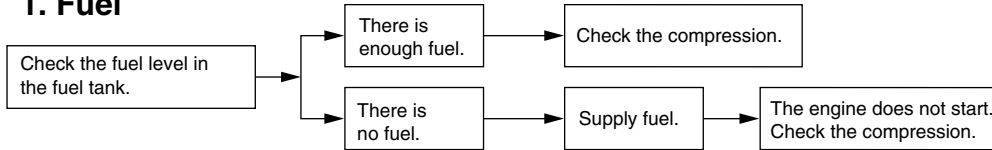

2. Compression

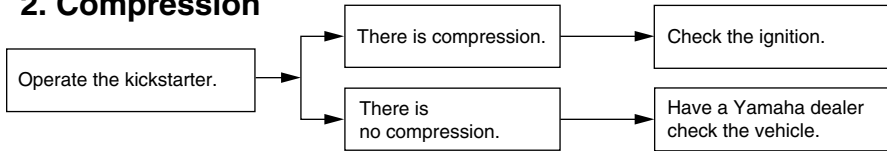

3. Ignition

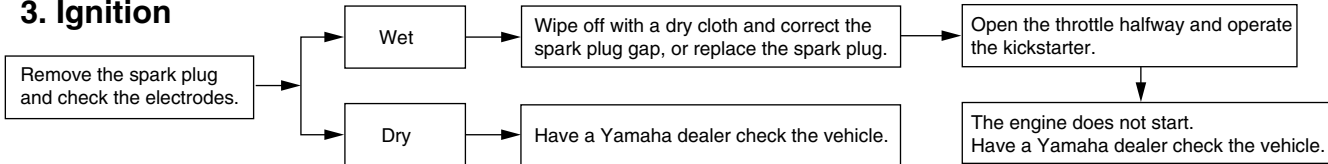

MOTORCYCLE CARE AND STORAGE

Matte color caution

EAU37833

EAU40464

NOTICE

Some models are equipped with matte colored finished parts. Be sure to consult a Yamaha dealer for advice on what products to use before cleaning the vehicle. Using a brush, harsh chemical products or cleaning compounds when cleaning these parts will scratch or damage their surface. Wax also should not be applied to any matte colored finished parts.

ECA15192

Care

While the open design of a motorcycle reveals the attractiveness of the technology, it also makes it more vulnerable. Rust and corrosion can develop even if high-quality components are used. A rusty exhaust pipe may go unnoticed on a car, however, it detracts from the overall appearance of a motorcycle. Frequent and proper care does not only comply with the terms of the warranty, but it will also keep your motorcycle looking good, extend its life and optimize its performance.

Before cleaning

1. Cover the muffler outlet with a plastic bag after the engine has cooled down.
2. Make sure that all caps and covers as well as all electrical couplers and connectors, including the spark plug cap, are tightly installed.
3. Remove extremely stubborn dirt, like oil burnt onto the crankcase, with a degreasing agent and a brush, but never apply such prod-

ucts onto seals, gaskets, sprockets, the drive chain and wheel axles. Always rinse the dirt and degreaser off with water.

Cleaning

ECA10772

NOTICE

- **Avoid using strong acidic wheel cleaners, especially on spoked wheels. If such products are used on hard-to-remove dirt, do not leave the cleaner on the affected area any longer than instructed. Also, thoroughly rinse the area off with water, immediately dry it, and then apply a corrosion protection spray.**
- **Improper cleaning can damage plastic parts (such as cowlings, panels, windshields, headlight lenses, meter lenses, etc.) and the mufflers. Use only a soft, clean cloth or sponge with water to clean plastic. However, if the plastic parts cannot be thoroughly cleaned with water, diluted mild detergent with water may be used. Be sure to rinse**

MOTORCYCLE CARE AND STORAGE

off any detergent residue using plenty of water, as it is harmful to plastic parts.

- Do not use any harsh chemical products on plastic parts. Be sure to avoid using cloths or sponges which have been in contact with strong or abrasive cleaning products, solvent or thinner, fuel (gasoline), rust removers or inhibitors, brake fluid, antifreeze or electrolyte.
- Do not use high-pressure washers or steam-jet cleaners since they cause water seepage and deterioration in the following areas: seals (of wheel and swing-arm bearings, fork and brakes), electric components (couplers, connectors, instruments, switches and lights), breather hoses and vents.
- For motorcycles equipped with a windshield: Do not use strong cleaners or hard sponges as they will cause dulling or scratching. Some cleaning compounds for plastic may leave

scratches on the windshield. Test the product on a small hidden part of the windshield to make sure that it does not leave any marks. If the windshield is scratched, use a quality plastic polishing compound after washing.

After normal use

Remove dirt with warm water, a mild detergent, and a soft, clean sponge, and then rinse thoroughly with clean water. Use a toothbrush or bottlebrush for hard-to-reach areas. Stubborn dirt and insects will come off more easily if the area is covered with a wet cloth for a few minutes before cleaning.

After riding in the rain or near the sea

Since sea salt is extremely corrosive, carry out the following steps after each ride in the rain or near the sea.

1. Clean the motorcycle with cold water and a mild detergent, after the engine has cooled down.

NOTICE: Do not use warm water since it increases the corrosive

action of the salt.^[ECA10791]

2. Apply a corrosion protection spray on all metal, including chrome- and nickel-plated, surfaces to prevent corrosion.

After cleaning

1. Dry the motorcycle with a chamois or an absorbing cloth.
2. Immediately dry the drive chain and lubricate it to prevent it from rusting.
3. Use a chrome polish to shine chrome, aluminum and stainless-steel parts, including the exhaust system. (Even the thermally induced discoloring of stainless-steel exhaust systems can be removed through polishing.)
4. To prevent corrosion, it is recommended to apply a corrosion protection spray on all metal, including chrome- and nickel-plated, surfaces.
5. Use spray oil as a universal cleaner to remove any remaining dirt.
6. Touch up minor paint damage caused by stones, etc.

MOTORCYCLE CARE AND STORAGE

7. Wax all painted surfaces.
8. Let the motorcycle dry completely before storing or covering it.

EWA14501

WARNING

Contaminants on the brakes or tires can cause loss of control.

- Make sure that there is no oil or wax on the tires.
- If necessary, wash the tires with warm water and a mild detergent. Before riding at higher speeds, test the motorcycle's braking performance and cornering behavior.

ECA10800

NOTICE

- Apply spray oil and wax sparingly and make sure to wipe off any excess.
- Never apply oil or wax to any rubber and plastic parts, but treat them with a suitable care product.
- Avoid using abrasive polishing compounds as they will wear away the paint.

TIP

- Consult a Yamaha dealer for advice on what products to use.
- Washing, rainy weather or humid climates can cause the headlight lens to fog. Turning the headlight on for a short period of time will help remove the moisture from the lens.

EAU40652

Storage

Short-term

Always store your motorcycle in a cool, dry place and, if necessary, protect it against dust with a porous cover.

ECA10810

NOTICE

- Storing the motorcycle in a poorly ventilated room or covering it with a tarp, while it is still wet, will allow water and humidity to seep in and cause rust.
- To prevent corrosion, avoid damp cellars, stables (because of the presence of ammonia) and areas where strong chemicals are stored.

Long-term

Before storing your motorcycle for several months:

1. Follow all the instructions in the "Care" section of this chapter.
2. For motorcycles equipped with a fuel cock that has an "OFF" position: Turn the fuel cock lever to

“OFF”.

3. Drain the carburetor float chamber by loosening the drain bolt; this will prevent fuel deposits from building up. Pour the drained fuel into the fuel tank.
4. Fill up the fuel tank and add fuel stabilizer (if available) to prevent the fuel tank from rusting and the fuel from deteriorating.
5. Perform the following steps to protect the cylinder, piston rings, etc. from corrosion.
 - a. Remove the spark plug cap and spark plug.
 - b. Pour a teaspoonful of engine oil into the spark plug bore.
 - c. Install the spark plug cap onto the spark plug, and then place the spark plug on the cylinder head so that the electrodes are grounded. (This will limit sparking during the next step.)
 - d. Turn the engine over several times with the starter. (This will coat the cylinder wall with oil.)
 - e. Remove the spark plug cap from the spark plug, and then

install the spark plug and the spark plug cap. **WARNING! To prevent damage or injury from sparking, make sure to ground the spark plug electrodes while turning the engine over.**^[EWA10951]

6. Lubricate all control cables and the pivoting points of all levers and pedals as well as of the sidestand.
7. Check and, if necessary, correct the tire air pressure, and then lift the motorcycle so that both of its wheels are off the ground. Alternatively, turn the wheels a little every month in order to prevent the tires from becoming degraded in one spot.
8. Cover the muffler outlet with a plastic bag to prevent moisture from entering it.

TIP

Make any necessary repairs before storing the motorcycle.

SPECIFICATIONS

Dimensions:

- Overall length:
1540 mm (60.6 in)
- Overall width:
640 mm (25.2 in)
- Overall height:
880 mm (34.6 in)
- Seat height:
635 mm (25.0 in)
- Wheelbase:
1055 mm (41.5 in)
- Ground clearance:
185 mm (7.28 in)
- Minimum turning radius:
1700 mm (66.9 in)

Weight:

- With oil and fuel:
61.0 kg (134 lb)

Noise and vibration level:

- Noise level (77/311/EEC):
PW80 79.3 dB(A)
- Vibration on seat (EN1032, ISO5008):
PW80 Will not exceed 0.5 m/s^2
- Vibration on handlebar (EN1032, ISO5008):
PW80 Will not exceed 2.5 m/s^2

Engine:

- Engine type:
Air cooled 2-stroke
- Cylinder arrangement:
Forward-inclined single cylinder
- Displacement:
 79 cm^3
- Bore × stroke:
 $47.0 \times 45.6 \text{ mm}$ ($1.85 \times 1.80 \text{ in}$)

- Compression ratio:
6.60 :1
- Starting system:
Kickstarter
- Lubrication system:
Separate lubrication (Yamaha autolube)

Engine oil:

- Type:
YAMALUBE 2 or 2-stroke engine oil (JASO FC grade) or (ISO EG-C or EG-D grade)

Engine oil quantity:

- Quantity:
0.75 L (0.79 US qt, 0.66 Imp.qt)

Transmission oil:

- Type:
YAMALUBE 4 (10W-40) or SAE 10W-40
- Oil change quantity:
0.65 L (0.69 US qt, 0.57 Imp.qt)

Air filter:

- Air filter element:
Wet element

Fuel:

- Recommended fuel:
PW80 Regular unleaded gasoline only
PW80Z Unleaded gasoline only
- Fuel tank capacity:
4.9 L (1.29 US gal, 1.08 Imp.gal)
- Fuel reserve amount:
1.0 L (0.26 US gal, 0.22 Imp.gal)

Carburetor:

- Type × quantity:
VM15SC x 1

Spark plug (s):

- Manufacturer/model:
PW80 NGK/BPR6HS
PW80Z NGK/BP6HS
DENSO/W20FP
- Spark plug gap:
0.6–0.7 mm (0.024–0.028 in)

Clutch:

- Clutch type:
Wet, multiple-disc automatic

Transmission:

- Primary reduction system:
Helical gear
- Primary reduction ratio:
66/21 (3.143)
- Secondary reduction system:
Chain drive
- Secondary reduction ratio:
32/15 (2.133)
- Transmission type:
Constant mesh 3-speed
- Operation:
Left foot operation

Gear ratio:

- 1st:
39/12 (3.250)
- 2nd:
29/16 (1.812)
- 3rd:
22/17 (1.294)

Chassis:

- Frame type:
Steel tube backbone
- Caster angle:

26.00 °

Trail:

62.0 mm (2.44 in)

Front tire:

Type:

With tube

Size:

2.50-14 4PR

Manufacturer/model:

CHENG SHIN/KNOBBY

Rear tire:

Type:

With tube

Size:

3.00-12 4PR

Manufacturer/model:

CHENG SHIN/KNOBBY

Loading:

Maximum rider weight:

40.0 kg (88 lb)

Tire air pressure (measured on cold tires):

Front:

100 kPa (1.00 kgf/cm², 15 psi)

Rear:

100 kPa (1.00 kgf/cm², 15 psi)

Front wheel:

Wheel type:

Spoke wheel

Rim size:

14x1.40

Rear wheel:

Wheel type:

Spoke wheel

Rim size:

12x1.60

Front brake:

Type:

Drum brake

Operation:

Right hand operation

Rear brake:

Type:

Drum brake

Operation:

Right foot operation

Front suspension:

Type:

Telescopic fork

Spring/shock absorber type:

Coil spring/oil damper

Wheel travel:

110.0 mm (4.33 in)

Rear suspension:

Type:

Swingarm (monocross)

Spring/shock absorber type:

Coil spring/gas-oil damper

Wheel travel:

95.0 mm (3.74 in)

Electrical system:

Ignition system:

CDI

CONSUMER INFORMATION

EAU40791

Identification numbers

Record the vehicle identification number and model label information in the spaces provided below for assistance when ordering spare parts from a Yamaha dealer or for reference in case the vehicle is stolen.

VEHICLE IDENTIFICATION NUMBER:

MODEL LABEL INFORMATION:

EAU26400

Vehicle identification number

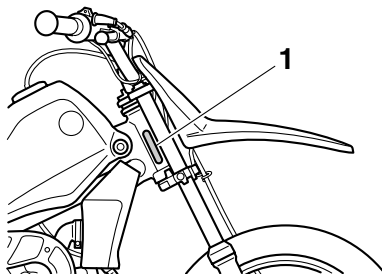

1. Vehicle identification number

The vehicle identification number is stamped into the steering head pipe. Record this number in the space provided.

TIP

The vehicle identification number is used to identify your motorcycle and may be used to register your motorcycle with the licensing authority in your area.

EAU26460

Model label

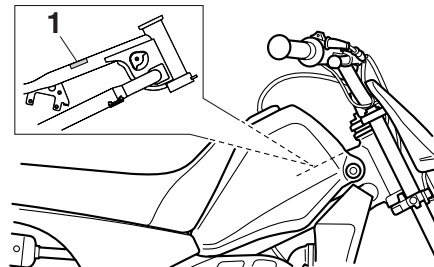

1. Model label

The model label is affixed to the location shown. Record the information on this label in the space provided. This information will be needed when ordering spare parts from a Yamaha dealer.

A		I	
Air filter element, cleaning	7-8	Identification numbers	10-1
Autolube pump, adjusting	7-19	K	
B		Kickstarter	4-6
Brake lever	4-2	L	
Brake lever, checking and lubricating	7-19	Labels, location	1-1
Brake lever free play, adjusting	7-14	M	
Brake pedal	4-2	Matte color, caution	8-1
Brake pedal, checking and lubricating	7-19	Model label	10-1
Brake pedal free play, adjusting	7-15	P	
Brake shoes, checking	7-15	Parking	6-4
C		Part locations	3-1
Cables, checking and lubricating	7-18	Periodic maintenance and lubrication chart	7-2
Carburetor, adjusting	7-10	Power reduction plate	4-1
Care	8-1	Power reduction plate, removing	7-6
D		S	
Drive chain, cleaning and lubricating	7-18	Safety information	2-1
Drive chain slack	7-16	Seat	4-7
E		Shifting	6-2
Engine break-in	6-3	Shift pedal	4-1
Engine idling speed	7-11	Shock absorber assembly	4-7
Engine oil	4-4	Sidestand	4-8
Engine, starting a warm	6-2	Sidestand, checking and lubricating	7-20
Engine stop switch	4-1	Spark arrester, cleaning	7-9
F		Spark plug, checking	7-5
Front fork, checking	7-20	Specifications	9-1
Fuel	4-3	Starter (choke) lever	4-6
Fuel cock	4-5	Starting and warming up a cold engine	6-1
Fuel tank breather hose	4-4	Steering, checking	7-21
Fuel tank cap	4-2	Storage	8-3
H		Supporting the motorcycle	7-22
Handlebar switch	4-1	T	
		Throttle cable free play, adjusting	7-11
		Throttle grip and cable, checking and lubricating	7-18
		Tires	7-12
		Tool kit	7-1
		Transmission oil	7-7
		Troubleshooting	7-26
		Troubleshooting chart	7-28
		V	
		Vehicle identification number	10-1
		W	
		Wheel bearings, checking	7-21
		Wheel (front)	7-22
		Wheel (rear)	7-25
		Wheels	7-13



YAMAHA MOTOR CO., LTD.

PRINTED ON RECYCLED PAPER

PRINTED IN JAPAN
2009.04-0.2x1 
(E)