



 Read this manual carefully before operating this vehicle.

OWNER'S MANUAL

EC-CO₂ 

EC-03

1CB-28199-EL



Read this manual carefully before operating this vehicle. This manual should stay with this vehicle if it is sold.

Welcome to the Yamaha world of motorcycling!

As the owner of the EC-03, you are benefiting from Yamaha's vast experience and newest technology regarding the design and manufacture of high-quality products, which have earned Yamaha a reputation for dependability.

Please take the time to read this manual thoroughly, so as to enjoy all advantages of your EC-03. The Owner's Manual does not only instruct you in how to operate, inspect and maintain your scooter, but also in how to safeguard yourself and others from trouble and injury.

In addition, the many tips given in this manual will help keep your scooter in the best possible condition. If you have any further questions, do not hesitate to contact your Yamaha dealer.

The Yamaha team wishes you many safe and pleasant rides. So, remember to put safety first!

Yamaha continually seeks advancements in product design and quality. Therefore, while this manual contains the most current product information available at the time of printing, there may be minor discrepancies between your scooter and this manual. If there is any question concerning this manual, please consult a Yamaha dealer.





Please read this manual carefully and completely before operating this scooter.

IMPORTANT MANUAL INFORMATION

EAU10133

Particularly important information is distinguished in this manual by the following notations:

	This is the safety alert symbol. It is used to alert you to potential personal injury hazards. Obey all safety messages that follow this symbol to avoid possible injury or death.
	A WARNING indicates a hazardous situation which, if not avoided, could result in death or serious injury.
	A NOTICE indicates special precautions that must be taken to avoid damage to the vehicle or other property.
TIP	A TIP provides key information to make procedures easier or clearer.

*Product and specifications are subject to change without notice.

IMPORTANT MANUAL INFORMATION

EAU10200

**EC-03
OWNER'S MANUAL
©2012 by Yamaha Motor Co., Ltd.
1st edition, May 2012
All rights reserved.
Any reprinting or unauthorized use
without the written permission of
Yamaha Motor Co., Ltd.
is expressly prohibited.
Printed in Japan.**

TABLE OF CONTENTS

SAFETY INFORMATION	1-1	FOR YOUR SAFETY –		Checking the front and rear brake	
Further safe-riding points	1-5	PRE-OPERATION CHECKS	5-1	shoes	8-9
Charging the battery safely	1-5			Checking and lubricating the	
		CHARGING THE BATTERY	6-1	cables	8-10
DESCRIPTION	2-1	Battery charging location	6-1	Lubricating the front and rear	
Left view	2-1	Charging procedure	6-3	brake levers	8-10
Right view	2-2	Charging time	6-8	Checking and lubricating the	
Controls and instruments.....	2-3	Display of charging progress		centerstand	8-11
		status	6-9	Checking the front fork	8-11
EC-03 FEATURES	3-1	About the battery	6-9	Checking the steering	8-12
Features	3-1			Checking the wheel bearings	8-12
Standard mode/power mode	3-1	OPERATION AND IMPORTANT		Replacing the headlight bulb	8-12
Traveling distance	3-2	RIDING POINTS	7-1	Replacing the tail/brake light	
Effective use of the battery	3-3	Preparations for starting off	7-1	bulb	8-14
Battery level	3-4	Starting off	7-3	Replacing a turn signal light	
		Acceleration and deceleration	7-4	bulb	8-14
INSTRUMENT AND CONTROL		Braking	7-5	Checking the charging cord and	
FUNCTIONS	4-1	Parking	7-5	charging plug	8-15
Beeper	4-1			Troubleshooting	8-16
Main switch/steering lock	4-1	PERIODIC MAINTENANCE AND			
Multi-function display	4-2	ADJUSTMENT	8-1	SCOOTER CARE AND STORAGE	9-1
Using the security lock	4-7	General maintenance and		Matte color caution	9-1
Handlebar switches	4-11	lubrication chart	8-2	Care	9-1
Front brake lever	4-11	Checking for irregular motor		Storage	9-3
Rear brake lever	4-12	sounds	8-5		
Seat	4-12	Checking the accelerator grip	8-5	SPECIFICATIONS	10-1
Helmet holder	4-13	Tires	8-6		
Luggage hook	4-13	Cast wheels	8-7	CONSUMER INFORMATION	11-1
Grab bar	4-14	Adjusting the front and rear brake		Identification numbers	11-1
		lever free play	8-8		



EAU50655

Be a Responsible Owner

As the vehicle's owner, you are responsible for the safe and proper operation of your scooter.

Scooters are single-track vehicles.

Their safe use and operation are dependent upon the use of proper riding techniques as well as the expertise of the operator. Every operator should know the following requirements before riding this scooter.

He or she should:

- Obtain thorough instructions from a competent source on all aspects of scooter operation.
- Observe the warnings and maintenance requirements in this Owner's Manual.
- Obtain qualified training in safe and proper riding techniques.
- Obtain professional technical service as indicated in this Owner's Manual and/or when made necessary by mechanical conditions.
- Never operate a scooter without proper training or instruction. Take

a training course. Beginners should receive training from a certified instructor. Contact an authorized scooter dealer to find out about the training courses nearest you.

Safe Riding

Perform the pre-operation checks each time you use the vehicle to make sure it is in safe operating condition. Failure to inspect or maintain the vehicle properly increases the possibility of an accident or equipment damage. See page 5-1 for a list of pre-operation checks.

- This scooter is designed to carry the operator only. No passengers.
- The failure of motorists to detect and recognize scooters in traffic is the predominating cause of automobile/scooter accidents. Many accidents have been caused by an automobile driver who did not see the scooter. Making yourself conspicuous appears to be very effective in reducing the chance of this type of accident.

Therefore:

- Wear a brightly colored jacket.

- Use extra caution when you are approaching and passing through intersections, since intersections are the most likely places for scooter accidents to occur.
- Ride where other motorists can see you. Avoid riding in another motorist's blind spot.
- Never maintain a scooter without proper knowledge. Contact an authorized scooter dealer to inform you on basic scooter maintenance. Certain maintenance can only be carried out by certified staff.
- Many accidents involve inexperienced operators. In fact, many operators who have been involved in accidents do not even have a current driver's license.
 - Make sure that you are qualified and that you only lend your scooter to other qualified operators.
 - Know your skills and limits. Staying within your limits may help you to avoid an accident.
 - We recommend that you prac-

SAFETY INFORMATION

1

tice riding your scooter where there is no traffic until you have become thoroughly familiar with the scooter and all of its controls.

- Many accidents have been caused by error of the scooter operator. A typical error made by the operator is veering wide on a turn due to excessive speed or undercornering (insufficient lean angle for the speed).
 - Always obey the speed limit and never travel faster than warranted by road and traffic conditions.
 - Always signal before turning or changing lanes. Make sure that other motorists can see you.
- The posture of the operator is important for proper control. The operator should keep both hands on the handlebar and both feet on the operator footrests during operation to maintain control of the scooter.
- Do not place magnets or objects with a strong magnetic force near the accelerator grip. In addition, do not place objects susceptible to magnetic forces (i.e., credit cards,

watches, etc.) close to the accelerator grip.

- Never ride under the influence of alcohol or other drugs.
- This scooter is designed for on-road use only. It is not suitable for off-road use.

Avoid submerged roads

Do not ride on flooded roads. Water could cause power unit failure, electric leakage, and/or short-circuiting.

Protective Apparel

The majority of fatalities from scooter accidents are the result of head injuries. The use of a safety helmet is the single most critical factor in the prevention or reduction of head injuries.

- Always wear an approved helmet.
- Wear a face shield or goggles. Wind in your unprotected eyes could contribute to an impairment of vision that could delay seeing a hazard.
- The use of a jacket, substantial shoes, trousers, gloves, etc., is effective in preventing or reducing abrasions or lacerations.

- Never wear loose-fitting clothes, otherwise they could catch on the control levers or wheels and cause injury or an accident.
- Always wear protective clothing that covers your legs, ankles, and feet. The power unit become hot during or after operation and can cause burns.

Loading

Adding accessories or cargo to your scooter can adversely affect stability and handling if the weight distribution of the scooter is changed. To avoid the possibility of an accident, use extreme caution when adding cargo or accessories to your scooter. Use extra care when riding a scooter that has added cargo or accessories. Here, along with the information about accessories below, are some general guidelines to follow if loading cargo to your scooter:

The total weight of the operator, accessories and cargo must not exceed the maximum load limit. **Operation of an overloaded vehicle could cause an accident.**



Maximum load:
87 kg (192 lb)

When loading within this weight limit, keep the following in mind:

- Cargo and accessory weight should be kept as low and close to the scooter as possible. Securely pack your heaviest items as close to the center of the vehicle as possible and make sure to distribute the weight as evenly as possible on both sides of the scooter to minimize imbalance or instability.
- Shifting weights can create a sudden imbalance. Make sure that accessories and cargo are securely attached to the scooter before riding. Check accessory mounts and cargo restraints frequently.
- Properly adjust the suspension for your load (suspension-adjustable models only), and check the condition and pressure of your tires.
- Never attach any large or heavy items to the handlebar, front fork, or front fender. Such items can create unstable handling or

a slow steering response.

- **This vehicle is not designed to pull a trailer or to be attached to a sidecar.**

Genuine Yamaha Accessories

Choosing accessories for your vehicle is an important decision. Genuine Yamaha accessories, which are available only from a Yamaha dealer, have been designed, tested, and approved by Yamaha for use on your vehicle.

Many companies with no connection to Yamaha manufacture parts and accessories or offer other modifications for Yamaha vehicles. Yamaha is not in a position to test the products that these aftermarket companies produce. Therefore, Yamaha can neither endorse nor recommend the use of accessories not sold by Yamaha or modifications not specifically recommended by Yamaha, even if sold and installed by a Yamaha dealer.

Aftermarket Parts, Accessories, and Modifications

While you may find aftermarket products similar in design and quality to

genuine Yamaha accessories, recognize that some aftermarket accessories or modifications are not suitable because of potential safety hazards to you or others. Installing aftermarket products or having other modifications performed to your vehicle that change any of the vehicle's design or operation characteristics can put you and others at greater risk of serious injury or death. You are responsible for injuries related to changes in the vehicle.

Keep the following guidelines in mind, as well as those provided under "Loading" when mounting accessories.

- Never install accessories or carry cargo that would impair the performance of your scooter. Carefully inspect the accessory before using it to make sure that it does not in any way reduce ground clearance or cornering clearance, limit suspension travel, steering travel or control operation, or obscure lights or reflectors.
- Accessories fitted to the handlebar or the front fork area can create instability due to improper weight distribution or aerody-

SAFETY INFORMATION

1

namic changes. If accessories are added to the handlebar or front fork area, they must be as lightweight as possible and should be kept to a minimum.

- Bulky or large accessories may seriously affect the stability of the scooter due to aerodynamic effects. Wind may attempt to lift the scooter, or the scooter may become unstable in cross winds. These accessories may also cause instability when passing or being passed by large vehicles.
- Certain accessories can displace the operator from his or her normal riding position. This improper position limits the freedom of movement of the operator and may limit control ability, therefore, such accessories are not recommended.
- Use caution when adding electrical accessories. If electrical accessories exceed the capacity of the scooter's electrical system, an electric failure could result, which could cause a dangerous loss of

lights or motor power.

Aftermarket Tires and Rims

The tires and rims that came with your scooter were designed to match the performance capabilities and to provide the best combination of handling, braking, and comfort. Other tires, rims, sizes, and combinations may not be appropriate. Refer to page 8-6 for tire specifications and more information on replacing your tires.

Transporting the Scooter

Be sure to observe following instructions before transporting the scooter in another vehicle.

- Remove all loose items from the scooter.
- Point the front wheel straight ahead on the trailer or in the truck bed, and choke it in a rail to prevent movement.
- Secure the scooter with tie-downs or suitable straps that are attached to solid parts of the scooter, such as the frame or upper front fork triple clamp (and not, for example, to rubber-mounted handlebars or

turn signals, or parts that could break). Choose the location for the straps carefully so the straps will not rub against painted surfaces during transport.

- The suspension should be compressed somewhat by the tie-downs, if possible, so that the scooter will not bounce excessively during transport.



EAU22031

Further safe-riding points

- Make sure to signal clearly when making turns.
- Braking can be extremely difficult on a wet road. Avoid hard braking, because the scooter could slide. Apply the brakes slowly when stopping on a wet surface.
- Slow down as you approach a corner or turn. Once you have completed a turn, accelerate slowly.
- Be careful when passing parked cars. A driver might not see you and open a door in your path.
- Railroad crossings, streetcar rails, iron plates on road construction sites, and manhole covers become extremely slippery when wet. Slow down and cross them with caution. Keep the scooter upright, otherwise it could slide out from under you.
- The brake lining could get wet when you wash the scooter. After washing the scooter, check the brakes before riding.
- Always wear a helmet, gloves, trousers (tapered around the cuff

and ankle so they do not flap), and a bright colored jacket.

- Do not carry too much luggage on the scooter. An overloaded scooter is unstable.

EAU50823

Charging the battery safely

- Do not charge the battery in areas potentially exposed to rain or water. This could cause an electric shock or short circuit.
- Be sure to plug the charging plug only directly to a grounded electrical outlet with residual-current device (RCD) protection to charge the battery. If incorrectly grounded, this could cause an electric shock or short circuit.

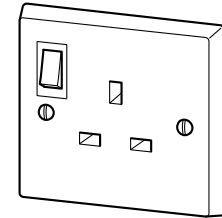

- If the vehicle is damaged due to overturning or accident, do not plug in the charging plug to an outlet. This could cause an electric shock or short circuit. Have your vehicle checked by a Yamaha



SAFETY INFORMATION

dealer as soon as possible.

- If the charging cord or charging plug is damaged, do not plug in to an outlet. This could cause an electric shock or short circuit. Have your vehicle checked by a Yamaha dealer as soon as possible.

Left view

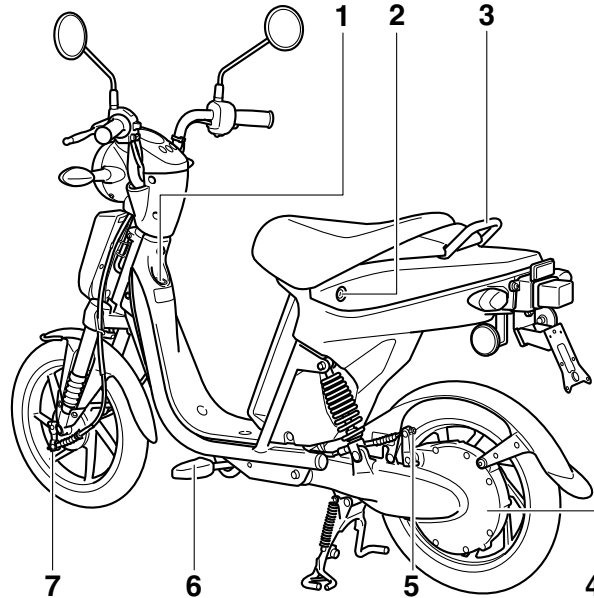

1. Main switch/steering lock (page 4-1)
2. Seat lock (page 4-12)
3. Grab bar (page 4-14)
4. Motor housing
5. Rear brake lever free play adjusting nut (page 8-8)
6. Footrest
7. Front brake lever free play adjusting nut (page 8-8)

DESCRIPTION

EAU10420

Right view

2

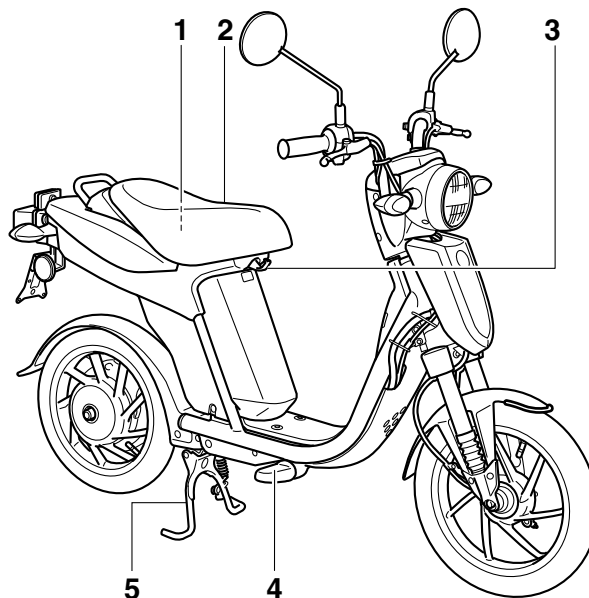

1. Charging cord (page 6-4)
2. Seat (page 4-12)
3. Luggage hook (page 4-13)
4. Footrest
5. Centerstand (page 8-11)

Controls and instruments

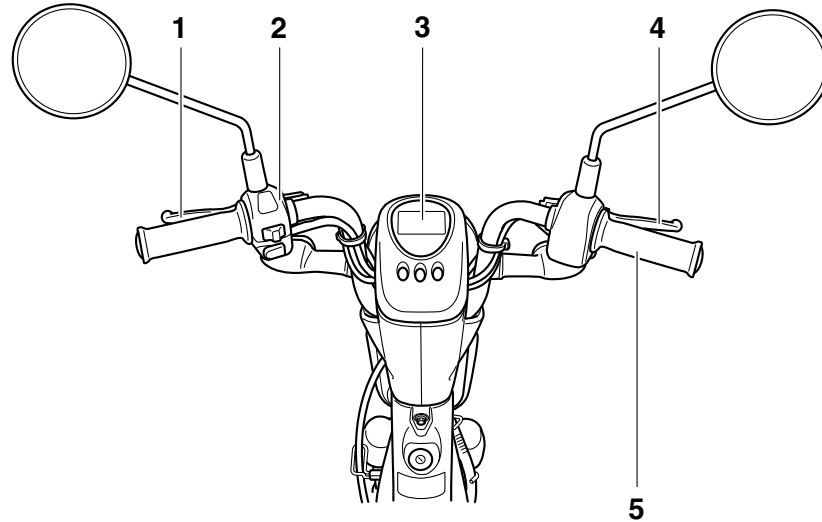

1. Rear brake lever (page 4-12)
2. Handlebar switches (page 4-11)
3. Multi-function display (page 4-2)
4. Front brake lever (page 4-11)
5. Accelerator grip (page 8-5)

EC-03 FEATURES

EAU50470

EAU50322

Features

The features of the EC-03 are following:

- The driving power source is only electricity and there is no need for fuel supply or engine oil change.
- High performance motor with greatly reduced noise and vibration providing a pleasant ride.
- Charging the vehicle can be done via a grounded electrical outlet with residual-current device (RCD) protection.

Standard mode/power mode

The motor driving power can be selected according to riding conditions, road conditions, etc.

The standard mode is suitable for normal riding, while the power mode provides more comfortable riding when ascending hills.

Switching the mode

Pushing button 1 “POWER” switches between the standard mode and the power mode.



POWER

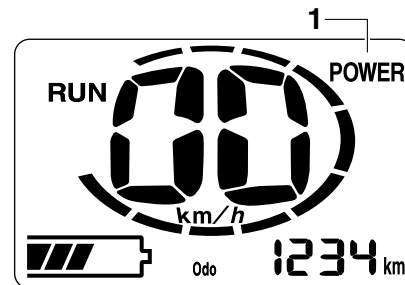

1. Power mode indicator “POWER”

When the power mode indicator “POWER” is displayed, the vehicle is set to the power mode. When the power mode indicator “POWER” is not displayed, the vehicle is set to the standard mode.

TIP

The mode that is currently set is stored in memory even if the key is turned to “OFF”.

Choosing the mode

Referring to the table below, choose the mode according to the riding conditions. The standard mode consumes less battery power so that the distance

traveled on a single charge increases.

EAU54030

Mode		Power*	Standard
Applicable conditions	Starting off	○	○
	Flat road	○	○
	Ascending	○	△
	Descending	○	○

- : Recommended mode for effective operation
- △ : Less effective operation than the power mode
- ★ : Distance traveled is shorter than the standard mode

Traveling distance

TIP

The distance that can be traveled on a single charge varies according to the riding and road conditions.

These conditions include the number of starts and stops, vehicle load, the steepness of slopes, road conditions, wind direction and velocity, ambient temperature, charging status, decreased battery performance, and low tire air pressure.

Distance traveled on a single charge

The data in the following chart was measured at Yamaha Motor Co., Ltd. It was measured when traveling with a new battery at an ambient temperature and vehicle load (total weight of rider and luggage) as shown below on a dry road surface in the absence of wind.

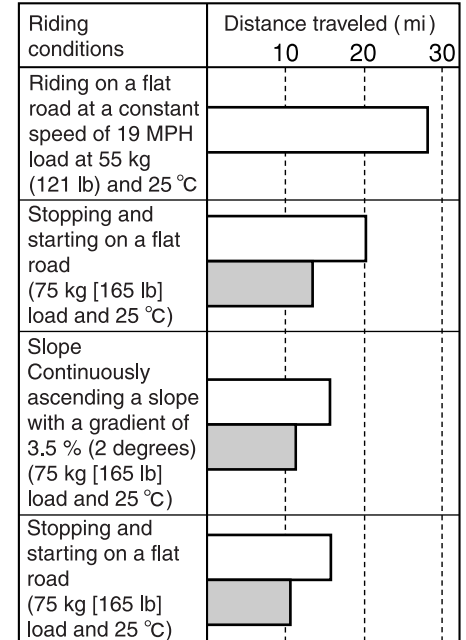

TIP

The maximum slope ascending capacity is a gradient of approximately 16% (about 9 degrees).

EC-03 FEATURES

3

- The distance that can be traveled becomes shorter when continuously riding in the power mode as compared with riding in the standard mode.
- Because of the battery character, the riding distance might be reduced according to the ambient temperature due to changes of the battery temperature.
- The distance that can be traveled becomes 5–10% shorter when the vehicle load is increased 10 kg (22 lb).

EAU50344

Effective use of the battery

If the battery is left nearly fully charged (4–5 segments shown on the battery charge indicator) and exposed to high temperature for an extended period, it will rapidly deplete. To extend the battery life, handle as follows:

- Choose a cool place with no direct sunlight when charging the battery.
- Do not store the battery with a charge less than 20% (below the last segment of the battery level indicator) for an extended period of time.
- Choose a cool and well-ventilated place without direct sunlight for storing the vehicle.
- When not used for a long period of time, charge the battery until the 2–3 segments of the battery charge indicator are shown and then store the vehicle in a cool place (optimum temperature 15 °C – 25 °C). Check the battery level while the vehicle is in storage. If the battery level drops to the last segment, recharge the battery until

2–3 segments of the battery charge indicator are shown.

ECA17072

NOTICE

If the battery is discharged until the battery is depleted, recharging will not be possible and the battery will not be usable.

Depleting battery image

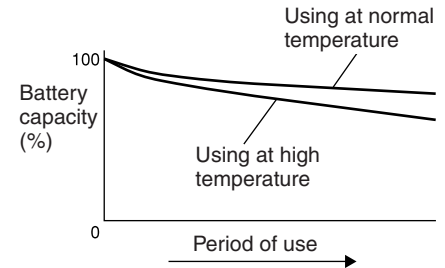

EAU50352

Battery level

TIP _____

Be sure to check the battery level before each ride.

Checking the battery level

Check the number of segments displayed in the battery level indicator.

TIP _____

While charging the battery, the indicator shows the progress status of charging. This differs from the indication of remaining charge when the vehicle is in use. See page 6-9.

Battery level indicator

When the key is turned to "ON", all segments of the battery level indicator come on for a few seconds, and then show a general indication of the remaining battery charge corresponding to the amount of the electric output.

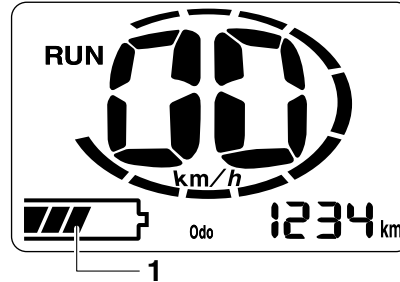

1. Battery level indicator

EC-03 FEATURES

Battery level reference table



Battery level (%)	Battery level indicator in the display	What to do
80—100		OK. Go ahead with riding.
60—80		
60		OK. Go ahead with riding. The 4th segment flashes to indicate that the remaining battery charge is now above half level.
40—60		OK. Go ahead with riding.
20—40		
10—20		Decreased ability to ascend slopes. Charge the battery.
0—10		The last segment flashes and the beeper sounds to indicate that the remaining battery charge is now about 10%. Stop riding immediately and charge the battery.
0		There is no battery charge left and it is impossible to ride. Charge the battery immediately. ※ This symbol may not be displayed depending on the battery condition.

INSTRUMENT AND CONTROL FUNCTIONS

Beeper

EAU49983

The EC-03 informs you of the following operations and status of the vehicle using the beeper.

- Key in "ON" position
- Standby mode (See page 7-2.)
- A control button is pushed
- Security lock unlocked
- Security lock unlock failed
- Enters the riding mode (see page 4-6).
- Turn signals in use
- Battery level is approx. 10% (See page 3-5.)
- Battery charging started

Main switch/steering lock

EAU10461

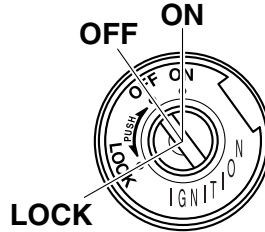

The main switch/steering lock controls the ignition and lighting systems, and is used to lock the steering. The various positions are described below.

ON

EAU50000

All electrical systems are supplied with power, and the headlight, meter lighting and taillight come on. The key cannot be removed.

TIP

To protect the battery, the EC-03 is equipped with an auto-off function. The power stops automatically if the vehicle is stopped for more than five minutes. To cancel the auto-off function, turn the

key to "OFF" and then back to "ON" again.

EAU10661

OFF

All electrical systems are off. The key can be removed.

EWA10061

! WARNING

Never turn the key to "OFF" or "LOCK" while the vehicle is moving. Otherwise the electrical systems will be switched off, which may result in loss of control or an accident.

EAU10684

LOCK

The steering is locked, and all electrical systems are off. The key can be removed.

INSTRUMENT AND CONTROL FUNCTIONS

To lock the steering

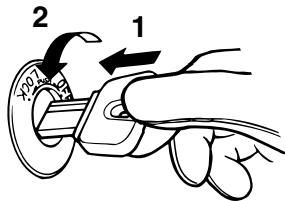

1. Push.
2. Turn.

1. Turn the handlebars all the way to the left.
2. Push the key in from the “OFF” position, and then turn it to “LOCK” while still pushing it.
3. Remove the key.

To unlock the steering

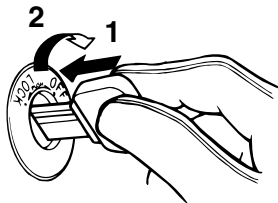

1. Push.
2. Turn.

Push the key in, and then turn it to “OFF” while still pushing it.

EAU54040

Multi-function display

EWA12312

⚠ WARNING

Be sure to stop the vehicle before making any setting changes to the multi-function display. Changing settings while riding can distract the operator and increase the risk of an accident.

INSTRUMENT AND CONTROL FUNCTIONS

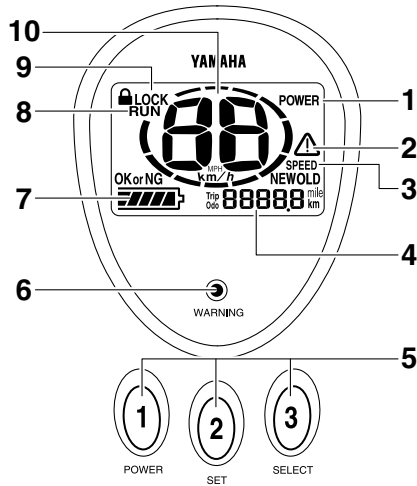

1. Power mode indicator “POWER”
2. Warning mark “ LOCK”
10. Speedometer

The EC-03 is equipped with a self-diagnosis device for the battery and control unit. When the key is turned to “ON”, the self-diagnosis starts automatically and all of the display segments of the multi-function meter appear. Once the self-diagnosis is completed, the display automatically changes to the standby mode. When in the standby mode, “PUSH” starts flashing.

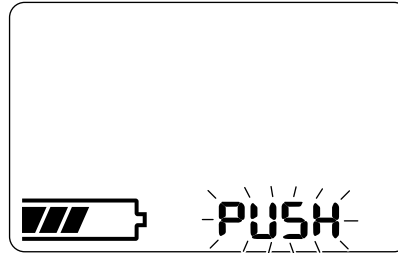

Push any of the following buttons to enter the riding mode.

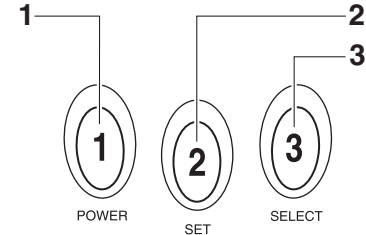

1. Button 1 “POWER”
2. Button 2 “SET”
3. Button 3 “SELECT”

When the vehicle is in the riding mode, the operating status indicator “RUN” and the ready indicators appear.

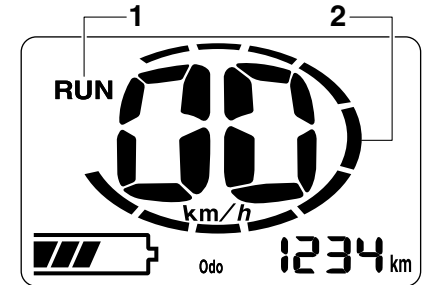

1. Operating status indicator “RUN”
2. Ready indicators

INSTRUMENT AND CONTROL FUNCTIONS

TIP _____
When the vehicle is in the riding mode, the beeper sounds. The beeper stops when either brake lever is squeezed or the vehicle starts moving.

Control buttons

Button 1 “POWER”

Button 2 “SET”

Button 3 “SELECT”

The following operations and settings are made using these buttons.

- Changing from the standby mode to the riding mode
- Switching between the standard mode and the power mode
- Switching between the odometer and the tripmeter
- Resetting the tripmeter
- Registering or changing the security number
- Locking and unlocking the security lock
- Switching between the “mile (MPH)” and “km (km/h)”

Speedometer

The speedometer shows the riding

speed.

Tripmeter “Trip”

The tripmeter shows the distance traveled since it was last set to zero. To reset the tripmeter, push and hold button 3 “SELECT” for a few seconds until “0.0” is displayed.

Odometer “Odo”

Push button 3 “SELECT” less than two seconds to switch the display to the odometer.

The odometer shows the total distance traveled. Use the odometer as a reference for the intervals between performing periodic maintenance.

Push button 3 “SELECT” less than two seconds to switch the display to the tripmeter.

Switching between the “mile (MPH)” and “km (km/h)”

To switch the speedometer and odometer/tripmeter displays between kilometers and miles, pushing button 3 “SELECT” and then turn the key to “ON”.

TIP _____
The current settings are kept until any setting changes are made.

Temperature warning display “HEAT”/“COOL”

The EC-03 is equipped with a temperature protection function to protect the battery and control unit.

If a problem is detected, the tripmeter/odometer display is canceled and “COOL” or “HEAT” flash.

- When the temperature of the battery or control unit exceeds a specified temperature, “HEAT” flashes.
- When the temperature of the battery falls below a specified temperature, “COOL” flashes.

TIP _____

- When the temperature of the battery exceeds a specified temperature, “HEAT” flashes and the driving power is reduced to limit the electric output from the battery, but this is normal.
- When the temperature of the battery falls below a specified temperature, “COOL” flashes and the

INSTRUMENT AND CONTROL FUNCTIONS

driving power is reduced to limit the electric output from the battery, but this is normal.

- If the vehicle is ridden for an extended period in high temperatures, “HEAT” may flash and the riding speed may be reduced.
- If the vehicle is ridden after it has been left in a hot place or under direct sunlight, “HEAT” may flash and the riding speed may be reduced.
- If the vehicle is ridden after it has been left in an excessively cold place (less than 0 °C), “COOL” may flash and the riding speed may be reduced.
- When the battery level indicator shows less than two segments, if the vehicle is exposed to higher temperatures, “COOL” may flash and the riding speed may be reduced.
- When riding on a long uphill stretch, “HEAT” may flash and the riding speed may be reduced.
- When riding on a long uphill stretch, the temperature of the control unit may rise and “HEAT”

may flash. If you ride continually, the operating status indicator “RUN” goes off to protect the control unit and further riding may be impossible, but this is not a malfunction.

The vehicle can be ridden when the operating status indicator “RUN” appears in the display, however riding speed may be reduced. This is due to reduced electric output from the battery because of high battery temperature.

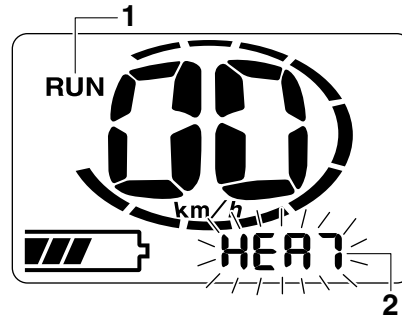

1. Operating status indicator “RUN”
2. Temperature indicator “HEAT”

If the battery level indicator shows less than two segments, or the electric output from the battery is limited because

of the battery temperature, the riding power is substantially reduced, but this is not a malfunction.

When the battery and control unit have reached their normal operating temperature and the operating status indicator “RUN” appears, the temperature warning display automatically changes back to the tripmeter/odometer display. If the operating status indicator “RUN” does not appear, the vehicle cannot be ridden.

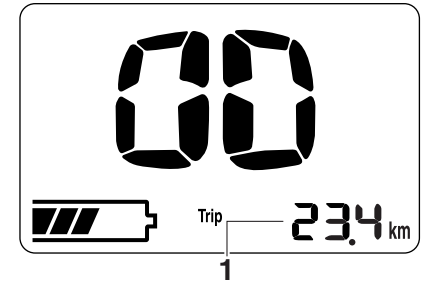

1. Tripmeter/odometer

Turn the key to “OFF” and allow the battery and control unit to cool down before riding again.

TIP _____
When the operating status indicator

INSTRUMENT AND CONTROL FUNCTIONS

“RUN” disappears and riding cannot be continued, the temperature warning display can be canceled by turning the key to “OFF” and then back to “ON” after the battery and control unit have cooled down.

EWA15631

WARNING

Before pushing or moving the EC-03, be sure to turn the key to “OFF”. The vehicle may suddenly start to move if the accelerator grip is turned while the key is turned to “ON”.

4

Speed warning indicator “SPEED”

If the vehicle speed exceeds 28 MPH (45 km/h), the speed warning indicator appears and the warning light flashes.

Operating status indicator “RUN”

This indicator appears when the vehicle can be ridden.

Battery level indicator

This indicator shows the remaining battery charge.

When only one battery indicator seg-

ment remains, recharge the battery as soon as possible. (See page 3-4 for more information about the battery level.)

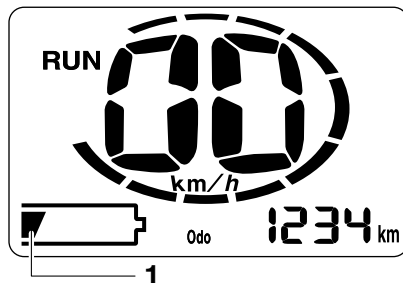



1. Battery level indicator

TIP

Make sure that the battery is sufficiently charged before riding.

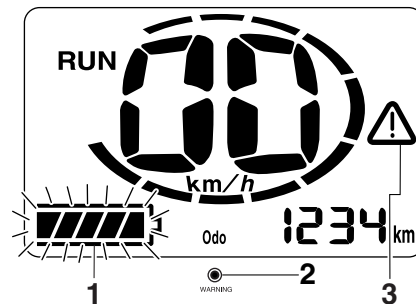
If the self-diagnosis detects a problem with the battery, the warning light comes on, the warning mark “” appears, and all segments of the battery level indicator flash. The electric output from the battery may also be reduced.



1. Battery level indicator
2. Warning light
3. Warning mark “”

The vehicle can still be ridden, but it must be checked by a Yamaha dealer as soon as possible.

Power mode indicator “POWER”

This indicator comes on when the vehicle is set to the power mode. (See “Switching the mode” on page 3-1 for switching the display between the standard mode and the power mode.)

INSTRUMENT AND CONTROL FUNCTIONS

Warning light

This warning light comes on or flashes as follows:

Speed warning indicator

The warning light flashes when vehicle speed exceeds 28 MPH (45 km/h). At the same time, the speed warning indicator "SPEED" appears.

Error warnings

If a problem is detected, the warning light comes on. In this case, check for the warning mark "⚠". If this warning mark also appears, have a Yamaha dealer check the vehicle.

Warning mark "⚠"

This warning mark flashes if a problem is detected. If the warning mark keeps flashing after turning the key to "OFF" and then back to "ON", have a Yamaha dealer check the vehicle.

TIP

After turning the key to "ON", the warning mark appears. If the warning mark goes out after a few seconds, there is no malfunction. Go ahead with riding.

EAU54100

Using the security lock

The EC-03 is equipped with a security lock that can be used by registering a security number. Once the security number has been set, the vehicle cannot be ridden unless the correct security number is entered, even if the key is turned to "ON".

Registering and changing the security number

EWA15611



Be sure to stop the vehicle before registering or changing the security number. Changing settings while riding can distract the operator and increase the risk of an accident.

TIP

The security number registration/change mode is canceled if the registering procedure is not completed in one minute. If the mode cancels, repeat the procedure.

1. Turn the key to "ON".

All display segments appear for a few seconds, then the vehicle en-

ters the standby mode and "PUSH" flashes.

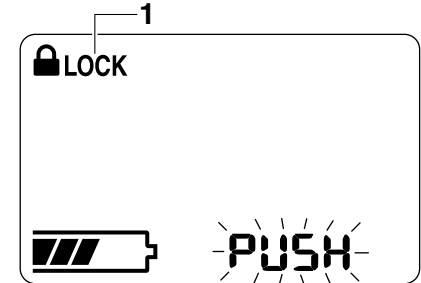

1. Security lock indicator "🔒 LOCK"

TIP

When the security lock has been locked, the security number indicator "🔒 LOCK" appears when the vehicle is in the standby mode.

2. Change to the riding mode by pushing any of the buttons.

INSTRUMENT AND CONTROL FUNCTIONS

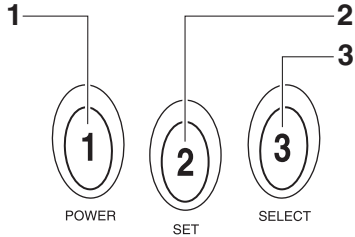

1. Button 1 “POWER”
2. Button 2 “SET”
3. Button 3 “SELECT”

The display shows that the vehicle is in the riding mode.

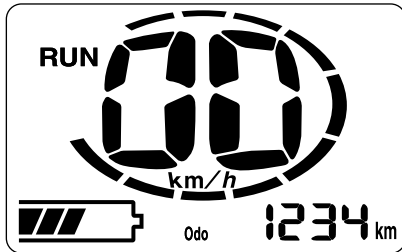

TIP

- When the security lock is locked, after changing to the riding mode, enter the security number to un-

lock the security lock. (See page 7-1 for more information about unlocking the security lock.)

- When the vehicle enters the riding mode, the beeper sounds. The beeper stops sounding when either brake lever is squeezed or the vehicle starts moving.

3. Press buttons 2 and 3 simultaneously.

The display changes to the security lock registration mode.

Registering the security number for the first time

Proceed to step 5.

Changing the security number

“OLD” and “- - - - -” are displayed.

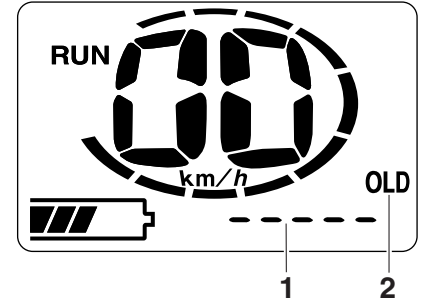

1. Input number indicator “-----”
2. Registered number indicator “OLD”

4. Use the buttons to enter the registered security number.

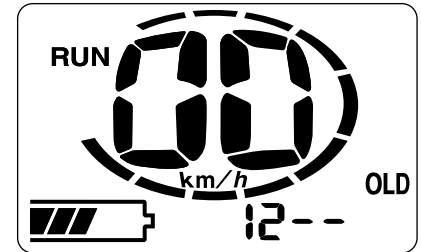

Proceed to step 5 if the correct security number is entered.

If an incorrect number is entered, the beeper sounds, “NG” flashes

INSTRUMENT AND CONTROL FUNCTIONS

for a few seconds, and the vehicle returns to the riding mode. Repeat the procedure from step 3.

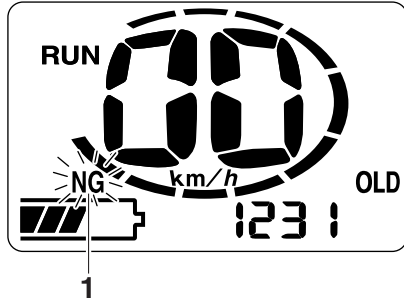

1. Incorrect number indicator “NG”

5. “NEW” and “- - - -” are displayed.

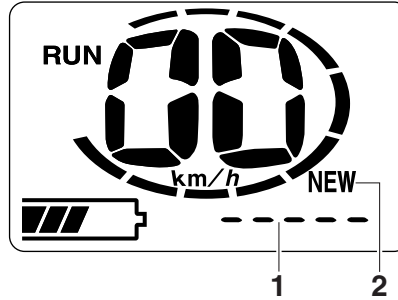

1. Input number indicator “- - - -”
2. New number indicator “NEW”

Enter a new security number.

The security number consists of a four-digit number. Enter a number using the buttons.

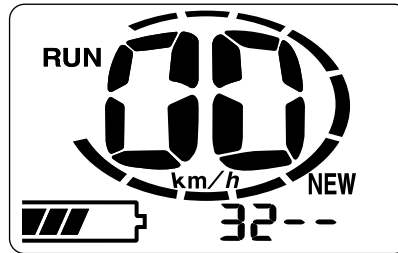

TIP

The number “1111” cannot be used as

a security number.

When a four-digit security number has been entered, “OK or NG” is displayed.

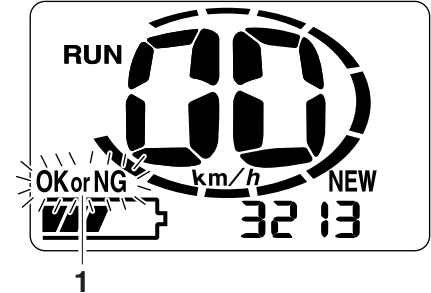

1. OK or NG indicator “OK or NG”

6. Push button 3 “SELECT” to display “OK”.

INSTRUMENT AND CONTROL FUNCTIONS

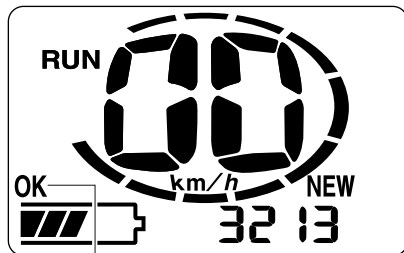

1

1. Number confirmation indicator “OK”

7. Push button 2 “SET”. The security number flashes for a few seconds, and then the vehicle enters the riding mode.

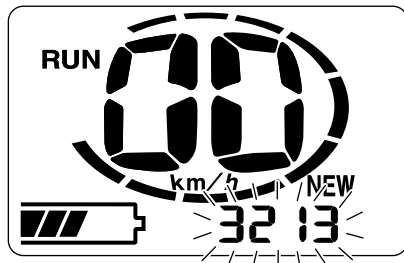

TIP

- Be sure to record the security number and keep it in a safe place.

- Pushing button 3 “SELECT” switches the display between “OK” and “NG”.
- To change the registered security number, switch the display to “NG” by pushing button 3 “SELECT”, and then push button 2 “SET”. Repeat the procedure from step 5.

Locking and unlocking the security lock

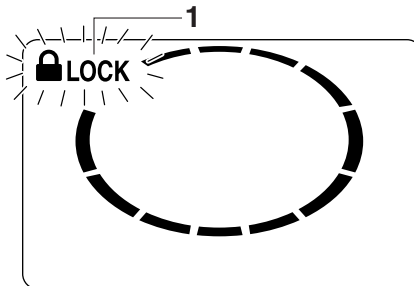

Locking the security lock

Push button 2 “SET” for at least two seconds, then the security lock indicator “ LOCK” starts flashing.



1. Security lock indicator “ LOCK”

Push button 2 “SET” again within three

seconds after the security lock indicator “ LOCK” starts flashing, then the security lock is locked and the security lock indicator “ LOCK” is displayed.

TIP

If button 2 “SET” is not pushed within three seconds or if another button is pushed, the security lock is canceled, and the vehicle returns to the riding mode.

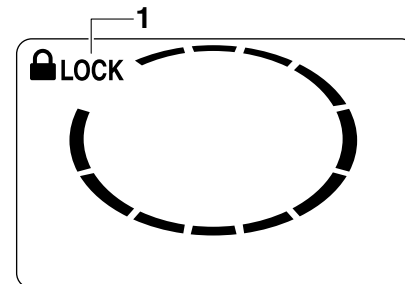

1. Security lock indicator “ LOCK”

TIP

Do not lock the security lock when having a Yamaha dealer perform service or repairs on the vehicle.

INSTRUMENT AND CONTROL FUNCTIONS

Unlocking the security lock

Change to the standby mode by pushing one of the buttons, then enter the security number. (See “Preparations for starting off” on page 7-1.)

Handlebar switches

EAU1234A

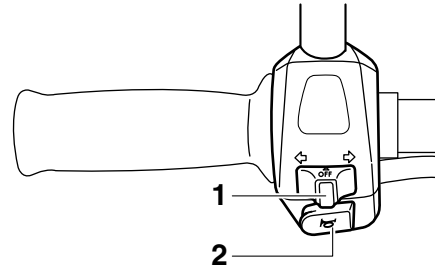

1. Turn signal switch “/”
2. Horn switch “”

Turn signal switch “/”

EAU12460

To signal a right-hand turn, push this switch to “”. To signal a left-hand turn, push this switch to “”. When released, the switch returns to the center position. To cancel the turn signal lights, push the switch in after it has returned to the center position.

EAU12500

Horn switch “”

Press this switch to sound the horn.

Front brake lever

EAU12901

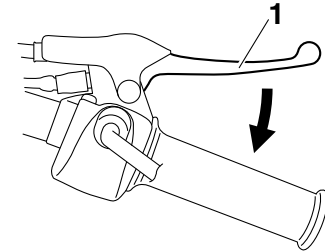

1. Front brake lever

The front brake lever is located on the right side of the handlebar. To apply the front brake, pull this lever toward the throttle grip.

INSTRUMENT AND CONTROL FUNCTIONS

EAU12951

Rear brake lever

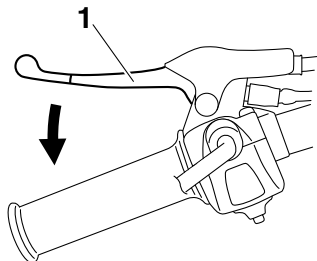

1. Rear brake lever

The rear brake lever is located on the left side of the handlebar. To apply the rear brake, pull this lever toward the handlebar grip.

EAUT3170

Seat

To open the seat

1. Place the vehicle on the center-stand.
2. Insert the key in the lock, and then turn it clockwise.

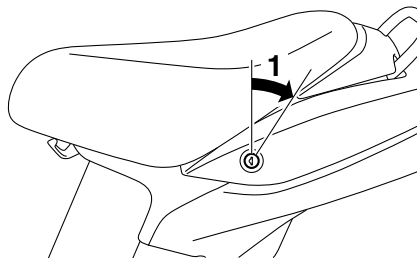

1. Unlock.
3. Fold the seat up.

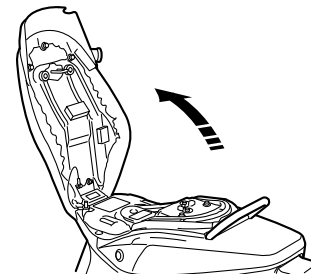

To close the seat

1. Fold the seat down, and then push it down to lock it in place.
2. Remove the key.

TIP

Make sure that the seat is properly secured before riding.

EAU50060

Helmet holder

The helmet holder is located under the seat. A helmet holding cable is provided under the seat to secure a helmet to the helmet holder.

To secure a helmet to the helmet holder

1. Open the seat. (See page 4-12.)
2. Pass the helmet holding cable through the buckle on the helmet strap as shown, and then hook the end of the helmet holding cable over the helmet holder.

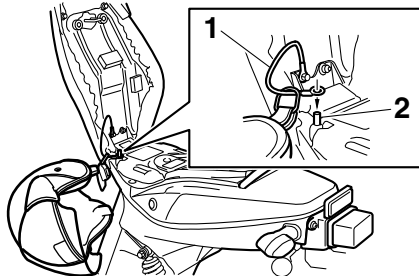

1. Helmet holding cable
2. Helmet holder

3. Securely close the seat.
WARNING! Never ride with a

helmet attached to the helmet holder, since the helmet may hit objects, causing loss of control and possibly an accident.^[EWA10161]

To release the helmet from the helmet holder

Open the seat, remove the helmet holding cable from the helmet holder and the helmet, and then close the seat.

EAUT1072

Luggage hook

EWAT1031

! WARNING

- Do not exceed the load limit of 1 kg (2 lb) for the luggage hook.
- Do not exceed the maximum load of 87 kg (192 lb) for the vehicle.

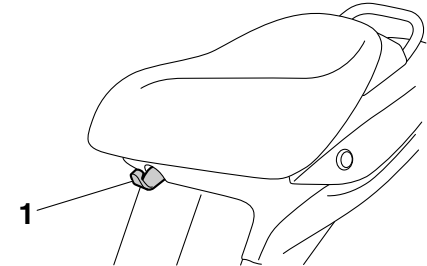

1. Luggage hook

INSTRUMENT AND CONTROL FUNCTIONS

EAU29910

Grab bar

Hold the grab bar with your right hand to place the vehicle on the centerstand.

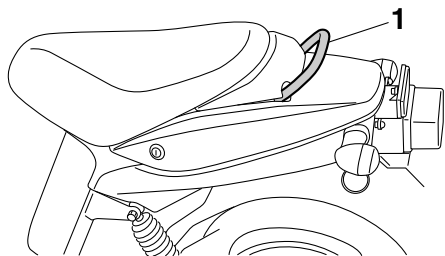

4

1. Grab bar

FOR YOUR SAFETY – PRE-OPERATION CHECKS

EAU15596

Inspect your vehicle each time you use it to make sure the vehicle is in safe operating condition. Always follow the inspection and maintenance procedures and schedules described in the Owner's Manual.

EWA11151

WARNING

Failure to inspect or maintain the vehicle properly increases the possibility of an accident or equipment damage. Do not operate the vehicle if you find any problem. If a problem cannot be corrected by the procedures provided in this manual, have the vehicle inspected by a Yamaha dealer.

Before using this vehicle, check the following points:

ITEM	CHECKS	PAGE
Front brake	<ul style="list-style-type: none">• Check operation.• Lubricate cable if necessary.• Check lever free play.• Adjust if necessary.	8-8
Rear brake	<ul style="list-style-type: none">• Check operation.• Lubricate cable if necessary.• Check lever free play.• Adjust if necessary.	8-8, 8-9
Control cables	<ul style="list-style-type: none">• Make sure that operation is smooth.• Lubricate if necessary.	8-10
Wheels and tires	<ul style="list-style-type: none">• Check for damage.• Check tire condition and tread depth.• Check air pressure.• Correct if necessary.	8-6, 8-7
Brake levers	<ul style="list-style-type: none">• Make sure that operation is smooth.• Lubricate lever pivoting points if necessary.	8-10
Centerstand	<ul style="list-style-type: none">• Make sure that operation is smooth.• Lubricate pivot if necessary.	8-11
Chassis fasteners	<ul style="list-style-type: none">• Make sure that all nuts, bolts and screws are properly tightened.• Tighten if necessary.	—

FOR YOUR SAFETY – PRE-OPERATION CHECKS

ITEM	CHECKS	PAGE
Instruments, lights, signals and switches	<ul style="list-style-type: none">• Check operation.• Correct if necessary.	—

EAU50561

EWA15761

⚠ WARNING

- If the vehicle is damaged due to overturning or accident, do not plug in the charging plug to the outlet. Otherwise it could cause an electric shock or short circuit. Have a Yamaha dealer check the charging plug before charging the battery.
- Charge the vehicle where no rain can get to it, as this could cause an electric shock or short circuit.
- Be sure to plug in the charging plug to a grounded electrical outlet with residual-current device (RCD) protection for charging the battery. If grounded incorrectly, this could cause an electric shock or short circuit.
- Do not remove the plastic cover under the seat to check the battery or built-in battery charger as this increases the risk of an electric shock or short circuit. If any problem is found, have a

Yamaha dealer check the vehicle.

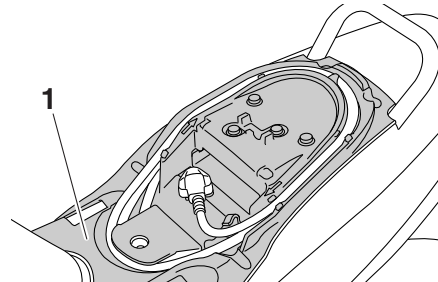

1. Plastic cover

EAU50383

EWA15872

Battery charging location

⚠ WARNING

Charging the battery incorrectly can cause electric shock or fire. Serious injury or death can occur if you ignore any of the following:

- Read all instructions and labels before charging the battery.
- Choose a dry location with a flat, stable surface that is protected from rain or water spray. The area must have good ventilation and be free of flammable objects or sources of heat.
- Be sure the vehicle, charging cord, and charging plug will not be disturbed by children or other bystanders, or animals.
- Connect the charging plug only directly to a grounded electrical outlet with residual-current device (RCD) protection. Do not use an ungrounded extension cord or multi-outlet plug with the charging cord.
- If your vehicle has been damaged due to overturn or acci-

CHARGING THE BATTERY

dent, do not plug in the charging cord. Have your vehicle checked by a Yamaha dealer as soon as possible.

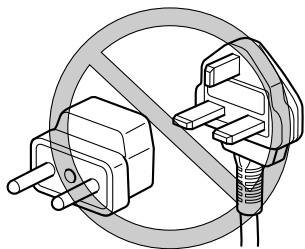
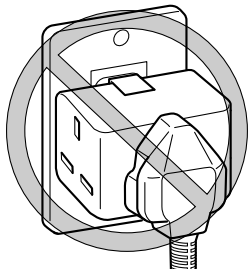

6

ECA17451

NOTICE

Improper charging can damage the battery and built-in battery charger.

- Do not charge in a place ex-

posed to direct sunlight or near a heater.

- Do not charge when there is risk of thunderstorms or lightning. Electrical surges could cause damage.
- Do not use the AC outlet of a car or generator for charging the battery as this could cause a malfunction.

Park the vehicle on a flat, stable surface near a grounded electrical outlet with residual-current device (RCD) protection. The area must be dry and, if necessary, sheltered to prevent rain water or other moisture from wetting the vehicle, charging cord, or outlet.

The environment affects the duration of battery charging. For optimum charging, charge the battery out of direct sunlight in an ambient temperature of 15 °C – 25 °C.

TIP

Although charging between 15 °C – 25 °C provides the best results, the battery can be charged within an ambient temperature range of –5 °C – 50 °C. A depleted battery cannot be charged if

ambient temperature is below 0 °C.

Examples of recommended charging locations

A cool, shaded and well-ventilated place.

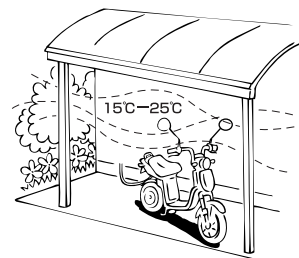

A place that does not fall below –5 °C overnight.

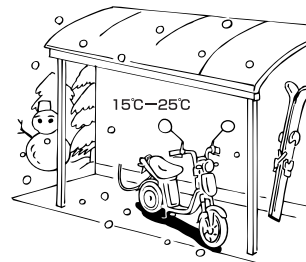

CHARGING THE BATTERY

Examples of unsuitable charging locations

Charging in a place exposed to direct sunlight or near a heater.

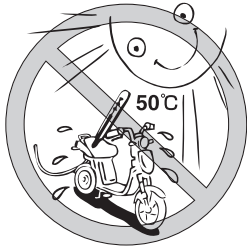

Charging in cold places such as in a storage shed, outdoors or in the winter.



Charging procedure

EAU53971

EWA15692

! WARNING

- Do not handle the charging plug with wet hands. You could be electrocuted.
- Do not charge the battery if any damage, corrosion, rust or looseness is found with the charging plug, charging cord or grounded electrical outlet. This could cause a fire, electric shock or short circuit.
- If any unusual odor or smoke emerges from the vehicle during charging, stop charging the battery immediately and consult your Yamaha dealer.
- Electromagnetic waves emitted from the battery charger could interfere with the function of heart devices or other electrical medical equipment and cause injury. If you use an implant-type cardiac pacemaker or defibrillator, or other electrical medical device, be sure to consult with your doctor or the

manufacturer to check whether being near the battery charger could affect the device.



EWA15881

! WARNING

Do not use the charging cord or charging plug if damaged (i.e., broken or exposed leads) because it could cause electric shock or fire. If such damage is found on the charging cord, stop using it immediately and have a Yamaha dealer check the vehicle. Handle the charging cord carefully by observing the following:

- Do not twist the charging cord, wrap it into a tight loop, or subject it to sharp bends.
- Be sure the charging cord cannot be caught in a door or win-

CHARGING THE BATTERY

dow.

- Do not pull or apply excessive force to the charging cord.
- Do not drop the charging cord or charging plug or expose it to strong impact.
- Do not secure the charging cord or charging plug in a place with sharp objects such as a nail.
- Do not step on the charging cord or charging plug or place any object on them.
- Do not leave the charging cord or charging plug near a heater or other source of heat.
- Do not modify the charging cord or charging plug.
- Park the vehicle carefully so the charging cord cannot be pinched, stepped on, or pulled accidentally. Also be sure the vehicle cannot be knocked over which could stretch or damage the charging cord or charging plug.
- Do not pull the charging cord to unplug the charging plug from the electrical outlet. Pull only

the charging plug.

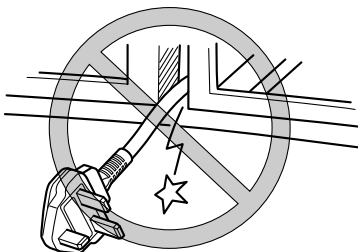

Starting charging

1. Place the vehicle on the center-stand.
2. Turn the key to "OFF".
3. Open the seat. (See page 4-12 for more information.)

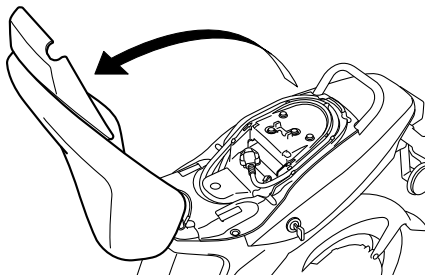

4. Grasp the charging plug, and then unwrap the charging cord from its

storing place as shown.

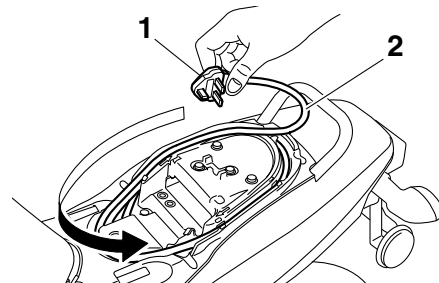

1. Charging plug
2. Charging cord

5. Place the charging cord in one of the grooves. **NOTICE: The charging cord may be damaged if not placed into a groove before closing the seat.**[ECA17460]

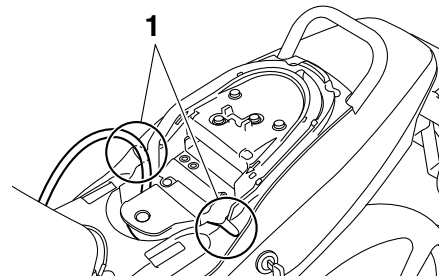

1. Groove

CHARGING THE BATTERY

6. Close the seat and push down on the back to lock it in position.

TIP

Before closing the seat, make sure that nothing is left under it.

7. Remove the key. To help prevent theft, be sure to lock the steering, and then remove the key when charging the battery.
8. Inspect the charging plug for any damage. Remove any dust, soil, oil or water with a dry cloth if necessary. Plug the charging plug into a grounded electrical outlet with residual-current device (RCD) protection.

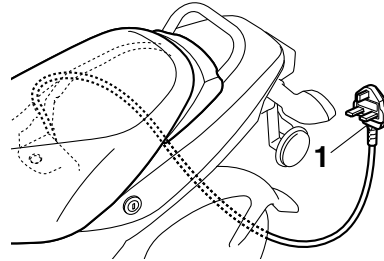
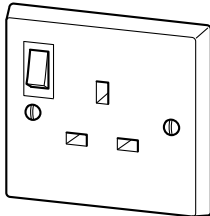

1. Charging plug

EWA15891

WARNING

To avoid serious injury or death from electric shock or fire:

- Do not use the charging plug if it has a damaged or loose prong. Have a Yamaha dealer check the vehicle.
- Check the charging plug for any foreign objects such as dust, soil, oil or water before charging. If necessary, wipe the plug clean with a dry cloth.
- Do not use an ungrounded extension cord or a multi-outlet plug between the charging cord and the outlet.
- Do not use the electrical outlet

along with other electrical equipment which may exceed the outlet's amperage and over-heat the outlet.

- Be sure to plug in the charging plug firmly.

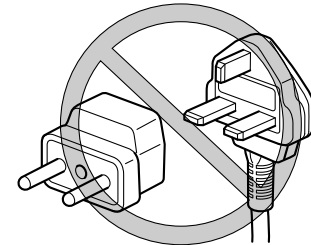
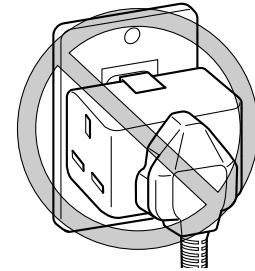

9. When the charging plug is plugged into an electrical outlet, charging starts automatically. The battery

CHARGING THE BATTERY

indicator level appears in the display and the beeper sounds. All indicator segments appear for a few seconds, and the charging progress status is shown.

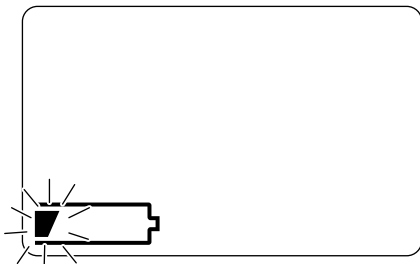

6

TIP

- The battery may be above the maximum 50 °C suitable for charging immediately after riding. In this case, the charger enters a waiting mode and “HEAT” flashes until the battery and battery charger reach the specified temperature. Charging then starts automatically.

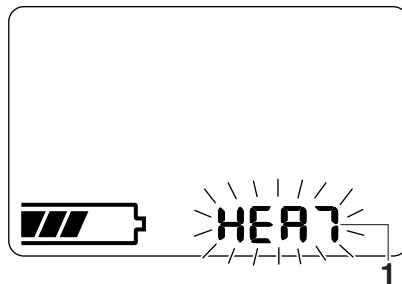

1. Temperature indicator “HEAT”

- If ambient temperature is below –5 °C, “COOL” flashes and the vehicle enters a waiting mode until the battery and battery charger reach the specified temperature. Charging then starts automatically.

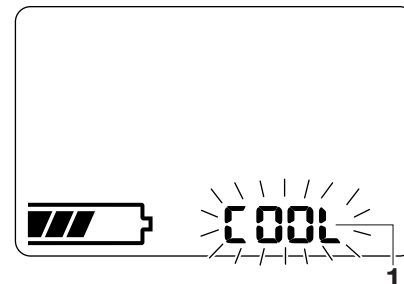

1. Temperature indicator “COOL”

- If the battery is already fully charged when the charging plug is plugged in, the display will show the fully charged status for a few minutes and then go off. The battery charger will not charge the battery further.

10. The battery charging status can be checked in the display. (See page 6-9 for more information about the charging status display.)
11. Charging can be stopped or restarted by unplugging or plugging in the charging plug.

TIP

- Only the battery level indicator ap-

CHARGING THE BATTERY

pears in the display during charging. The display goes off if the charging plug is unplugged during charging.

- Even if the key is turned to “ON”, the vehicle does not enter the standby mode during charging.

Completing charging

When the battery is fully charged, the display goes off automatically after a few minutes.

1. Grasp the charging plug, and then unplug it from the electrical outlet.

NOTICE: Do not pull the charging cord to unplug the charging plug from the electrical outlet. This could damage the charging cord.^[ECA17470]

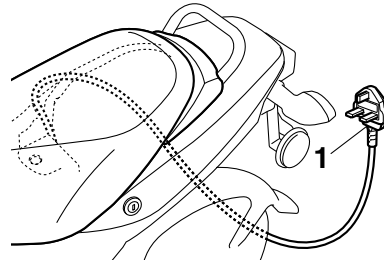

1. Charging plug

2. Open the seat. (See page 4-12 for more information.)

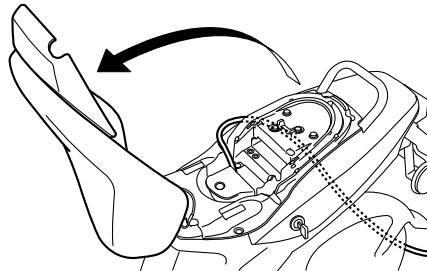

3. Hold the charging plug, and while pressing the charging cord into the groove, wind it clockwise as shown. **NOTICE: If the charging cord is not wound properly, the vehicle, charging cord or charg-**

ing plug can be damaged when closing the seat.^[ECA17480]

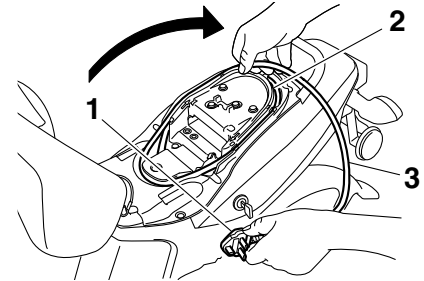

1. Charging plug
2. Groove
3. Charging cord

4. Insert 2 pins of the charging plug into the hole in the plastic cover.

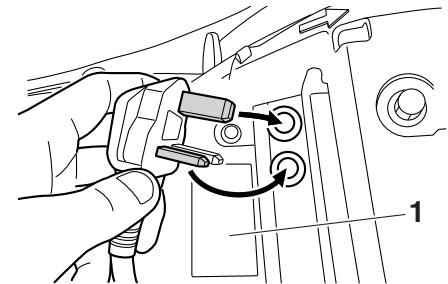

1. Charging cord storage label

CHARGING THE BATTERY

TIP
See the charging cord storage label for routing the charging cord.

5. Close the seat, and push down on the back to lock it in position.

TIP

- Before closing the seat, make sure that nothing is left under the seat.
- Make sure that the seat is securely locked before riding.

6. Remove the key.

EWA15900

WARNING

When not in use, do not leave the charging plug plugged into an outlet. Dust or foreign objects could build up and cause a fire. Be sure to unplug the charging plug from the outlet after use.

Charging time

EAU50402

Normal charging

Charging time varies depending on the riding conditions before charging, remaining battery level, and ambient temperature. It takes approximately seven hours to charge the battery from a 0% charged level in the optimum ambient temperature range of 15 °C – 25 °C.

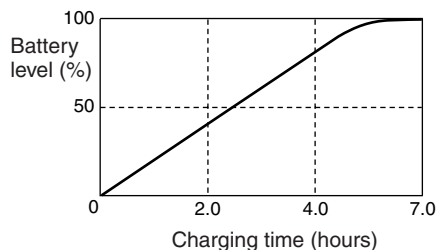

TIP
When the charging process is completed, the power from the built-in battery charger is cut off automatically.

Waiting mode for charging

The vehicle enters a waiting mode if the

temperature is not suitable for charging as follows:

- The battery may be above the maximum 50 °C immediately after riding. In this case, the charger enters a waiting mode and “HEAT” flashes until the battery and battery charger reach the specified temperature.
- If ambient temperature is below –5 °C, “COOL” flashes until the battery and battery charger reach the specified temperature.





When the temperature is suitable for charging, charging starts automatically.

EAU50411

EAU5050

Display of charging progress status

The charging process is displayed by the battery level indicator.

Charging progress status (%)	Charging progress status in the display
0–20	
20–40	
40–60	
60–80	
80–99	
100	Not displayed

 Lit  Flashing

About the battery

Lithium-ion (Li-ion) battery

The Li-ion battery used in the EC-03 features high energy density and has a high voltage (approximately three times that of nickel-cadmium (Ni-Cd) or nickel-hydrogen (Ni-MH) batteries), meaning it can be made both compact and lightweight.

Nickel-cadmium and nickel-hydrogen batteries have a memory effect that causes electric output capacity to decrease as a result of repeated partial discharging and charging, so that they need to have to be completely discharged periodically. Li-ion batteries can be repeatedly partially charged without requiring fully discharging.

TIP

- It is not necessary to use up the battery before charging.
- The electric output capacity decreases over time and use, but the rate at which it depletes depends on condition of use.
- The battery discharge may vary depending on the ambient temper-

ature. At low temperatures, the traveling distance on a single charge is reduced compared with normal temperatures and charging also takes longer. At low temperatures, the electric output capacity decreases, compared with normal temperatures, and traveling distance on a single charge is reduced, but this is normal.

- Storing the vehicle in an extremely hot or cold place could decrease the electric output capacity.
- Even if the battery is not used, the battery discharges gradually.

Recycling the battery

Li-ion batteries can be recycled. If the electric output capacity decreases excessively due to depletion, have a Yamaha dealer replace the battery. Always follow local regulations regarding the disposal of batteries.

CHARGING THE BATTERY

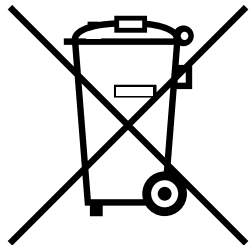

Battery depletion

The electric output capacity of the Li-ion battery used in the EC-03 gradually decreases in the course of use. Although the extent of depletion varies based on the conditions of use, electric output capacity typically decreases to 70% of a new battery when having traveled 5000–6250 mi (8000–10000 km) for two years. This is equivalent to charging about 500 times with the condition of riding 10–12.5 mi (16–20 km) on a single charge.

Battery electric output auto-stopping function

The battery is equipped with a function to prevent further use in case of excessive depletion. When eight years have

passed since initial battery charging or the accumulated charging amount has reached 14000 Ah, the battery will no longer be usable.

TIP

- When the battery is replaced with a new one, fully charge the battery once before using it. If the battery is not fully charged, the battery level indicator does not show the precise battery level.
 - At low temperatures such as 0 °C, the electric output capacity decreases by approximately 20% compared with normal temperature.
 - If a depleted battery is used at low temperatures, the electric output capacity decreases by approximately 20% compared with normal temperatures.
-

OPERATION AND IMPORTANT RIDING POINTS

EAU15951

Read the Owner's Manual carefully to become familiar with all controls. If there is a control or function you do not understand, ask your Yamaha dealer.

EWA10271

WARNING

Failure to familiarize yourself with the controls can lead to loss of control, which could cause an accident or injury.

EAU50093

Preparations for starting off

TIP

Make sure the accelerator grip is closed before starting off. An error could occur if the accelerator grip is turned.

1. Stand on the left side of the vehicle.

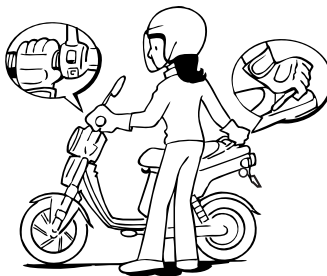

2. While pulling the rear brake lever with your left hand and holding the grab bar with your right hand, push the vehicle off the centerstand.

EWA15661

WARNING

Before placing the vehicle on or pushing it off the centerstand or sitting on the seat, be sure the key is "OFF". Otherwise, the vehicle could

start moving unexpectedly if the accelerator grip is turned accidentally.

3. Put your right foot on the footrest, and sit on the seat. At the same time support the vehicle with your left foot so that the vehicle does not fall over.



4. Squeeze the rear brake with your left hand to prevent the vehicle from moving.

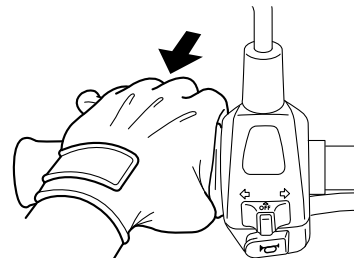

OPERATION AND IMPORTANT RIDING POINTS

5. Turn the key to "ON".



After all displays come on for a few seconds, the vehicle enters the standby mode.

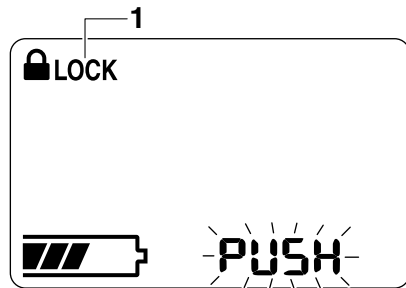

1. Security lock indicator "LOCK"

TIP

- When the security lock is locked, the security lock indicator

"LOCK" comes on.

- If the accelerator grip is turned while the vehicle is in the standby mode, the beeper sounds.

6. Cancel the standby mode by pressing one of the buttons.

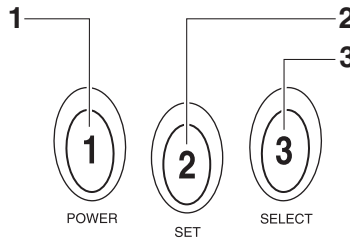

1. Button 1 "POWER"
2. Button 2 "SET"
3. Button 3 "SELECT"

The vehicle enters the security lock unlocking mode.

"-----" is displayed.

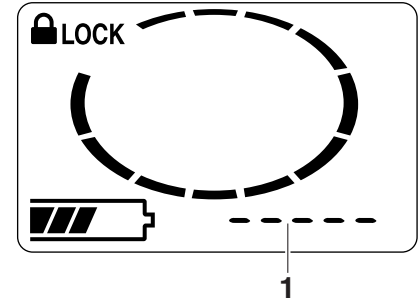

1. Input number indicator "-----"

TIP

If the security lock is not locked, after canceling the standby mode, the vehicle enters the riding mode. When the vehicle is in the riding mode, the beeper sounds. The beeper stops sounding when either brake lever is squeezed or the vehicle starts moving. Proceed to step 8.

7. Enter the security number using the buttons.

Entering the correct number unlocks the security lock and the vehicle enters the riding mode.

OPERATION AND IMPORTANT RIDING POINTS

EAU50103

TIP

When the vehicle enters the riding mode, the beeper sounds. The beeper stops sounding when either brake lever is squeezed or the vehicle starts moving.

If the entered security number is incorrect, the buzzer sounds, “NG” flashes for a few seconds, and the vehicle returns to the standby mode.

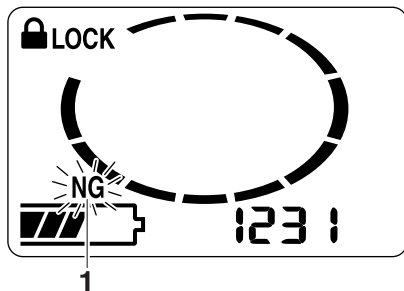

1. Incorrect number indicator “NG”

If this occurs, repeat the procedure from the step 6.

TIP

If an incorrect security number is entered three times in succession, the security lock cannot be unlocked even if the correct security number is entered. Repeat the procedure after first turning the key to “OFF” and then back to “ON” again.

8. Check the battery level indicator to make sure that the remaining charged level is sufficient. (See page 3-4 for more information about the charge level.)

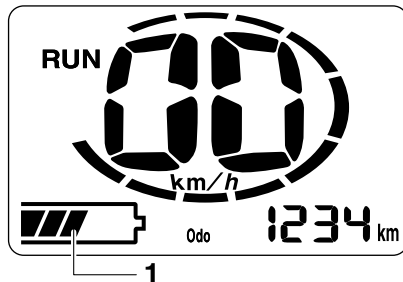

1. Battery level indicator

Starting off

1. Check that the operating status indicator “RUN” is displayed, and that the vehicle is in the riding mode.

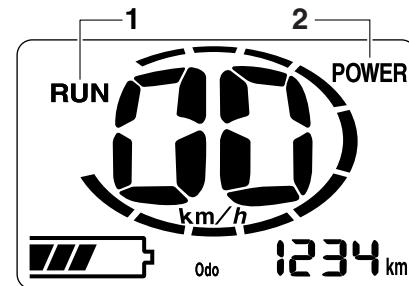

1. Operating status indicator “RUN”
2. Power mode indicator “POWER”

TIP

If the vehicle is set to the power mode, the power mode indicator “POWER” is displayed. (See page 3-1 for more information about switching the display between the standard mode and the power mode.)

2. Switch the turn signal on.

OPERATION AND IMPORTANT RIDING POINTS

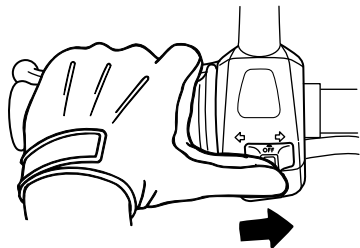

TIP
The beeper sounds while the turn signal switch is signaling.

3. Check in front of and behind the vehicle to make sure that it is safe to start off.
4. Release the rear brake lever.
5. Check for oncoming traffic, and then slowly turn the accelerator grip in order to start off.

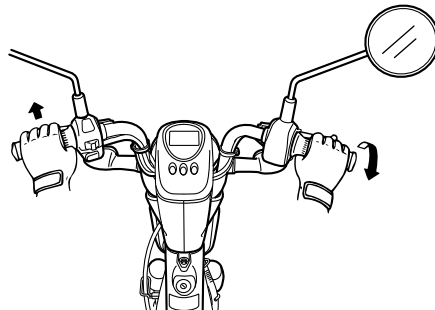

6. Push the turn signal switch to cancel the turn signals.

TIP
To protect the battery, the EC-03 is equipped with an auto-off function. The power stops automatically if the vehicle is stopped for more than five minutes. To restart the vehicle after the vehicle has been stopped for more than five minutes, turn the key to “OFF” and then back to “ON” again.

EAU50111

Acceleration and deceleration

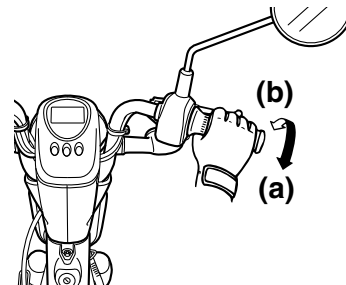

The speed can be adjusted by opening and closing the accelerator grip. To increase the speed, turn the accelerator grip in direction (a). To reduce the speed, turn the accelerator grip in direction (b).

OPERATION AND IMPORTANT RIDING POINTS

Braking

EAU50961

Front

EWA10300

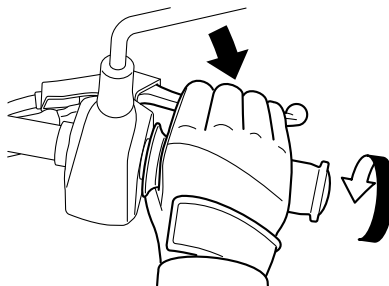

Rear

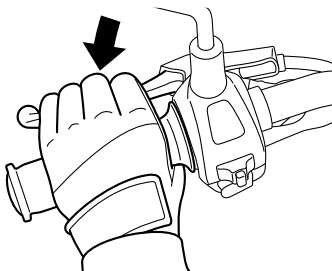

WARNING

- Avoid braking hard or suddenly (especially when leaning over to one side), otherwise the scooter may skid or overturn.
- Railroad crossings, streetcar rails, iron plates on road construction sites, and manhole covers become extremely slippery when wet. Therefore, slow down when approaching such areas and cross them with caution.
- Keep in mind that braking on a wet road is much more difficult.
- Ride slowly down a hill, as braking downhill can be very difficult.

1. Close the accelerator grip completely.
2. Apply both front and rear brakes simultaneously while gradually increasing the pressure.

EAU50122

Parking

To prevent theft, be sure to lock the steering and remove the key when parking. It is recommended to additionally use a chain lock or other type of motorcycle lock.

EWA15580

WARNING

Do not park on a slope or on soft ground, otherwise the vehicle may overturn.

TIP

- If the vehicle is parked in an extremely hot or cold place, the temperature protection function may be activated when the key is turned to "ON". If this is activated, "HEAT" or "COOL" flashes on the tripmeter/odometer display. (See page 4-4 "Temperature warning display" for more information about the temperature protection function.)
- It is recommended to lock the security lock when parking. (See page 4-10 for more information about locking the security lock.)

PERIODIC MAINTENANCE AND ADJUSTMENT

EAU50130

Periodic inspection, adjustment, and lubrication will keep your vehicle in the safest and most efficient condition possible. Safety is an obligation of the vehicle owner/operator. The most important points of vehicle inspection, adjustment, and lubrication are explained on the following pages.

The intervals given in the periodic maintenance charts should be simply considered as a general guide under normal riding conditions. However, depending on the weather, terrain, geographical location, and individual use, the maintenance intervals may need to be shortened.

EWA10321

WARNING

Failure to properly maintain the vehicle or performing maintenance activities incorrectly may increase your risk of injury or death during service or while using the vehicle. If you are not familiar with vehicle service, have a Yamaha dealer perform service.

EWA15840

WARNING

Turn the key to “OFF” when performing maintenance unless otherwise specified. A running motor has moving parts that can catch on body parts or clothing and electrical parts that can cause shocks or fires.

EWA15830

WARNING

This scooter is designed for use on paved roads only.

EWA15460

WARNING

Brake discs, calipers, drums, and linings can become very hot during use. To avoid possible burns, let brake components cool before touching them.

PERIODIC MAINTENANCE AND ADJUSTMENT

EAU54060

TIP

- The annual checks must be performed every year, except if a kilometer-based maintenance is performed instead.
- From 18800 mi (30000 km), repeat the maintenance intervals starting from 3800 mi (6000 km).
- Items marked with an asterisk should be performed by a Yamaha dealer as they require special tools, data and technical skills.

EAU54070

General maintenance and lubrication chart

NO.	ITEM	CHECK OR MAINTENANCE JOB	ODOMETER READING					ANNUAL CHECK	
			600 mi (1000 km)	3800 mi (6000 km)	7500 mi (12000 km)	11300 mi (18000 km)	15000 mi (24000 km)		
1	*	Front brake	• Check operation and adjust brake lever free play.	√	√	√	√	√	√
			• Replace brake shoes.	Whenever worn to the limit					
2	*	Rear brake	• Check operation and adjust brake lever free play.	√	√	√	√	√	√
			• Replace brake shoes.	Whenever worn to the limit					
3	*	Wheels	• Check runout and for damage.		√	√	√	√	
4	*	Tires	• Check tread depth and for damage. • Replace if necessary. • Check air pressure. • Correct if necessary.		√	√	√	√	√
5	*	Wheel bearings	• Check bearing for looseness or damage.		√	√	√	√	

PERIODIC MAINTENANCE AND ADJUSTMENT

NO.	ITEM	CHECK OR MAINTENANCE JOB	ODOMETER READING					ANNUAL CHECK	
			600 mi (1000 km)	3800 mi (6000 km)	7500 mi (12000 km)	11300 mi (18000 km)	15000 mi (24000 km)		
6	*	Steering bearings	• Check bearing play and steering for roughness.	√	√	√	√	√	
			• Lubricate with lithium-soap-based grease.	Every 15000 mi (24000 km)					
7	*	Chassis fasteners	• Make sure that all nuts, bolts and screws are properly tightened.		√	√	√	√	√
8		Front brake lever pivot shaft	• Lubricate with lithium-soap-based grease.		√	√	√	√	√
9		Rear brake lever pivot shaft	• Lubricate with lithium-soap-based grease.		√	√	√	√	√
10		Centerstand	• Check operation. • Lubricate.		√	√	√	√	√
11	*	Front fork	• Check operation and for oil leakage.		√	√	√	√	
12	*	Shock absorber assembly	• Check operation and shock absorber for oil leakage.		√	√	√	√	
13	*	Front and rear brake switches	• Check operation.	√	√	√	√	√	√
14		Moving parts and cables	• Lubricate.		√	√	√	√	√
15	*	Accelerator grip	• Check operation. • Correct if necessary.		√	√	√	√	√
16	*	Lights, signals and switches	• Check operation. • Adjust headlight beam.	√	√	√	√	√	√
17	*	Motor noise	• Check for irregular noise coming from the motor. • Correct if necessary.	√	√	√	√	√	√

PERIODIC MAINTENANCE AND ADJUSTMENT

NO.	ITEM	CHECK OR MAINTENANCE JOB	ODOMETER READING					ANNUAL CHECK	
			600 mi (1000 km)	3800 mi (6000 km)	7500 mi (12000 km)	11300 mi (18000 km)	15000 mi (24000 km)		
18	*	Charging cord and plug	<ul style="list-style-type: none"> • Check condition and for damage. • Replace if necessary. 	√	√	√	√	√	√

PERIODIC MAINTENANCE AND ADJUSTMENT

EAU50143

Checking for irregular motor sounds

Check the motor for irregular sounds.

TIP

The motor cannot be revved beyond a certain motor speed by turning the accelerator grip when the vehicle is on the centerstand.

EAU50155

Checking the accelerator grip

Before checking the accelerator grip, check the following points.

- Make sure that the key is in the "OFF" position. Turn the accelerator grip slowly and check that it moves smoothly, and returns smoothly when released.
- Check for any signs of deterioration or damage around the accelerator grip. Also check the accelerator grip holder mounting bolts for tightness.
- When washing the vehicle, avoid spraying the area around the accelerator grip with water. If the area around the accelerator grip is particularly dirty, use a well-wrung damp cloth to clean.

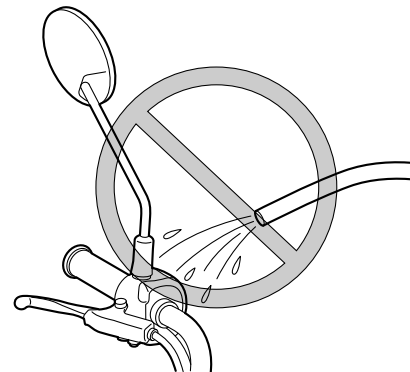

EWA15672

! WARNING

If a problem is found in accelerator grip operation, do not operate the vehicle. Have the vehicle inspected by a Yamaha dealer. Continuing to use the vehicle with a problem increases the possibility of an accident or equipment damage.

1. Squeeze the rear brake lever with your left hand.
2. Turn the key to "ON".
3. Cancel the standby mode by pressing one of the control buttons. (See page 4-2.)
4. Make sure that the operating sta-

PERIODIC MAINTENANCE AND ADJUSTMENT

tus indicator “RUN” is displayed, and that the vehicle is in the riding mode. (See page 7-1 for more information about “Preparations for starting off” and “Starting off”.)

5. Check that the accelerator grip and motor operate smoothly when the vehicle is accelerated by gradually turning the accelerator grip while riding the vehicle. If there is a problem, have a Yamaha dealer check the vehicle.

Tires

Tires are the only contact between the vehicle and the road. Safety in all conditions of riding depends on a relatively small area of road contact. Therefore, it is essential to maintain the tires in good condition at all times and replace them at the appropriate time with the specified tires.

Tire air pressure

The tire air pressure should be checked and, if necessary, adjusted before each ride.

WARNING

Never overload your vehicle. Operation of an overloaded vehicle could cause an accident.

EAU50674

Tire air pressure (measured on cold tires):

- Front:
200 kPa (2.00 kgf/cm², 29 psi)
Rear:
250 kPa (2.50 kgf/cm², 36 psi)

Maximum load*:

- 87 kg (192 lb)
* Total weight of rider, cargo and accessories

Tire inspection

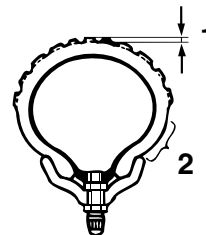

1. Tire tread depth
2. Tire sidewall

The tires must be checked before each ride. If the center tread depth reaches the specified limit, if the tire has a nail or glass fragments in it, or if the sidewall is cracked, have a Yamaha dealer re-

PERIODIC MAINTENANCE AND ADJUSTMENT

place the tire immediately.

Minimum tire tread depth (front and rear):
1.6 mm (0.06 in)

TIP

The tire tread depth limits may differ from country to country. Always comply with the local regulations.

Tire information

This vehicle is equipped with cast wheels and tube tires.

Tires age, even if they have not been used or have only been used occasionally. Cracking of the tread and sidewall rubber, sometimes accompanied by carcass deformation, is an evidence of ageing. Old and aged tires shall be checked by tire specialists to ascertain their suitability for further use.

After extensive tests, only the tires listed below have been approved for this model by Yamaha Motor Co., Ltd.

Front tire:

Size:
60/100-12 36J
Manufacturer/model:
INOUE RUBBER/MB80

Rear tire:

Size:
60/100-12 36J
Manufacturer/model:
INOUE RUBBER/MB80

EWA10471

WARNING

- **Have a Yamaha dealer replace excessively worn tires. Besides being illegal, operating the vehicle with excessively worn tires decreases riding stability and can lead to loss of control.**
- **The replacement of all wheel and brake-related parts, including the tires, should be left to a Yamaha dealer, who has the necessary professional knowledge and experience to do so.**
- **Ride at moderate speeds after changing a tire since the tire surface must first be “broken in” for it to develop its optimal characteristics.**

EAU22003

Cast wheels

EWA10610

WARNING

The wheels on this model are not designed for use with tubeless tires. Do not attempt to use tubeless tires on this model.

To maximize the performance, durability, and safe operation of your vehicle, note the following points regarding the specified wheels.

- The wheel rims should be checked for cracks, bends, warpage or other damage before each ride. If any damage is found, have a Yamaha dealer replace the wheel. Do not attempt even the smallest repair to the wheel. A deformed or cracked wheel must be replaced.
- The wheel should be balanced whenever either the tire or wheel has been changed or replaced. An unbalanced wheel can result in poor performance, adverse handling characteristics, and a shortened tire life.

PERIODIC MAINTENANCE AND ADJUSTMENT

EAU22152

Adjusting the front and rear brake lever free play

The front and rear brake lever free play should be measured at the positions as shown.

Front

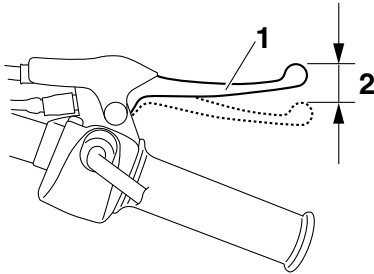

1. Front brake lever
2. Brake lever free play

Rear

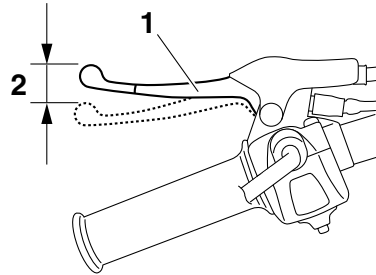

1. Rear brake lever
2. Brake lever free play

Front brake lever free play:
10.0–20.0 mm (0.39–0.79 in)
Rear brake lever free play:
10.0–20.0 mm (0.39–0.79 in)

Periodically check the front and rear brake lever free play and, if necessary, adjust them as follows.

To increase the brake lever free play, turn the adjusting nut at the brake shoe plate in direction (a). To decrease the brake lever free play, turn the adjusting nut in direction (b).

Front

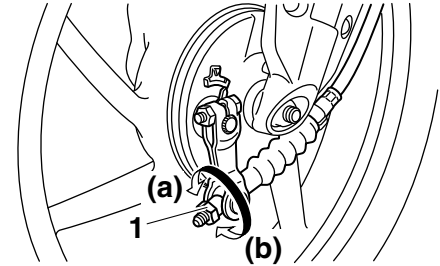

1. Front brake lever free play adjusting nut

Rear

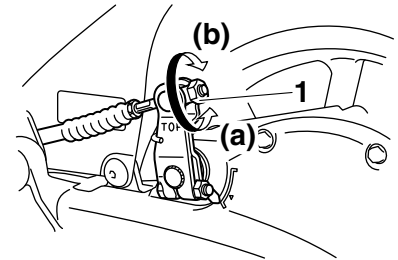

1. Rear brake lever free play adjusting nut



WARNING

If proper adjustment cannot be obtained as described, have a Yamaha

EWA10650

PERIODIC MAINTENANCE AND ADJUSTMENT

dealer make this adjustment.

EAU22361

Checking the front and rear brake shoes

Front

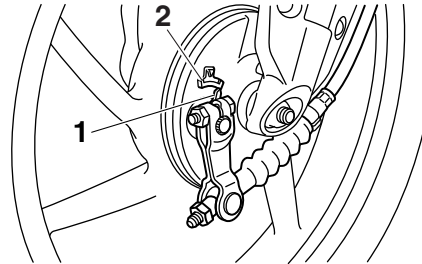

1. Brake shoe wear indicator
2. Brake shoe wear limit line

The front and rear brake shoes must be checked for wear at the intervals specified in the periodic maintenance and lubrication chart. Each brake is provided with a wear indicator, which allows you to check the brake shoe wear without having to disassemble the brake. To check the brake shoe wear, check the position of the wear indicator while applying the brake. If a brake shoe has worn to the point that the wear indicator reaches the wear limit line, have a Yamaha dealer replace the brake shoes as a set.

Rear

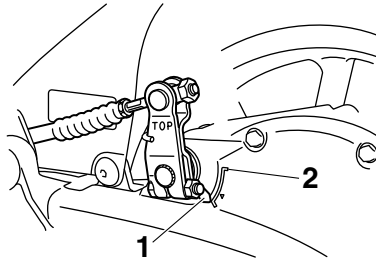

1. Brake shoe wear indicator
2. Brake shoe wear limit line

PERIODIC MAINTENANCE AND ADJUSTMENT

EAU23095

Checking and lubricating the cables

The operation of all control cables and the condition of the cables should be checked before each ride, and the cables and cable ends should be lubricated if necessary. If a cable is damaged or does not move smoothly, have a Yamaha dealer check or replace it. **WARNING! Damage to the outer housing of cables may result in internal rusting and cause interference with cable movement. Replace damaged cables as soon as possible to prevent unsafe conditions.**^[EWA10711]

Recommended lubricant:

Yamaha Chain and Cable Lube or engine oil

EAU43631

Lubricating the front and rear brake levers

Front brake lever

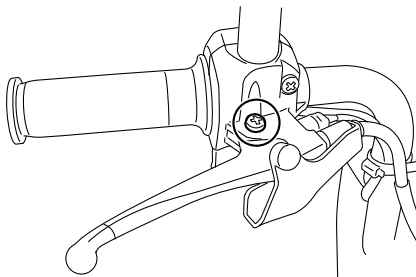

Rear brake lever

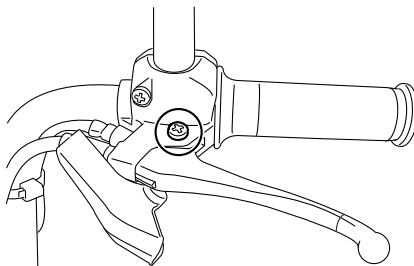

Recommended lubricant:
Lithium-soap-based grease

The pivoting points of the front and rear brake levers must be lubricated at the intervals specified in the periodic maintenance and lubrication chart.

PERIODIC MAINTENANCE AND ADJUSTMENT

Checking and lubricating the centerstand

EAU23192

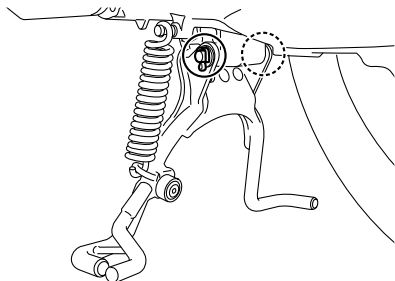

The operation of the centerstand should be checked before each ride, and the pivots and metal-to-metal contact surfaces should be lubricated if necessary.

EWA11301

WARNING

If the centerstand does not move up and down smoothly, have a Yamaha dealer check or repair it. Otherwise, the centerstand could contact the ground and distract the operator, resulting in a possible loss of control.

Recommended lubricant:
Lithium-soap-based grease

Checking the front fork

EAU42081

The condition and operation of the front fork must be checked as follows at the intervals specified in the periodic maintenance and lubrication chart.

To check the condition

Check the inner tubes for scratches and damage.

To check the operation

1. Place the vehicle on a level surface and hold it in an upright position. **WARNING! To avoid injury, securely support the vehicle so there is no danger of it falling over.**^[EWA10751]
2. While applying the front brake, push down hard on the handlebars several times to check if the front fork compresses and rebounds smoothly.

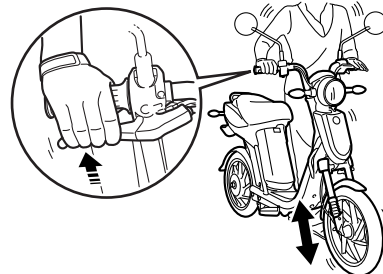

ECA10590

NOTICE

If any damage is found or the front fork does not operate smoothly, have a Yamaha dealer check or repair it.

PERIODIC MAINTENANCE AND ADJUSTMENT

EAU45511

Checking the steering

Worn or loose steering bearings may cause danger. Therefore, the operation of the steering must be checked as follows at the intervals specified in the periodic maintenance and lubrication chart.

1. Place the vehicle on the center-stand. **WARNING! To avoid injury, securely support the vehicle so there is no danger of it falling over.**^[EWA10751]
2. Hold the lower ends of the front fork legs and try to move them forward and backward. If any free play can be felt, have a Yamaha dealer check or repair the steering.

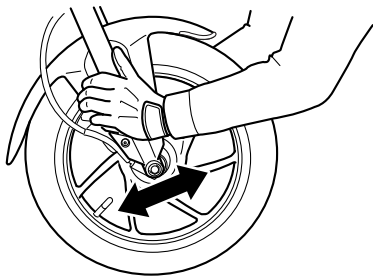

EAU23291

Checking the wheel bearings

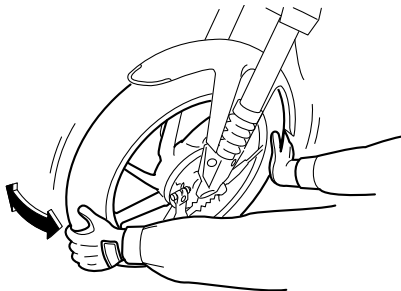

The front and rear wheel bearings must be checked at the intervals specified in the periodic maintenance and lubrication chart. If there is play in the wheel hub or if the wheel does not turn smoothly, have a Yamaha dealer check the wheel bearings.

EAU23798

Replacing the headlight bulb

This model is equipped with a halogen bulb headlight. If the headlight bulb burns out, replace it as follows.

ECA10650

NOTICE

Take care not to damage the following parts:

- **Headlight bulb**
Do not touch the glass part of the headlight bulb to keep it free from oil, otherwise the transparency of the glass, the luminosity of the bulb, and the bulb life will be adversely affected. Thoroughly clean off any dirt and fingerprints on the headlight bulb using a cloth moistened with alcohol or thinner.
- **Headlight lens**
Do not affix any type of tinted film or stickers to the headlight lens.
Do not use a headlight bulb of a wattage higher than specified.

PERIODIC MAINTENANCE AND ADJUSTMENT

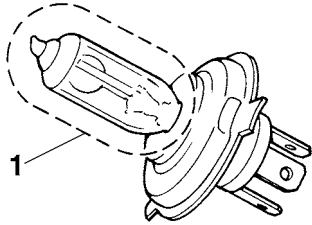

1. Do not touch the glass part of the bulb.

1. Remove the headlight unit by removing the screws.

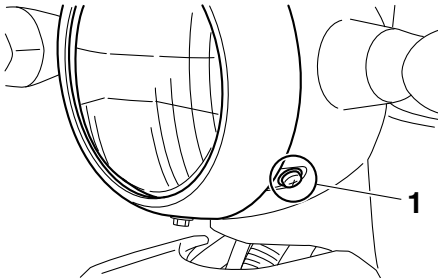

1. Screw

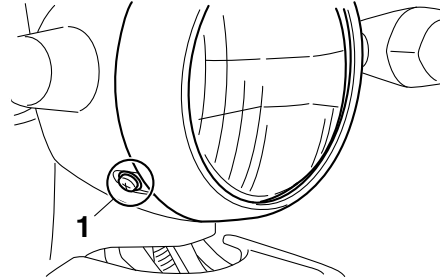

1. Screw

2. Disconnect the headlight coupler, and then remove the headlight bulb cover.

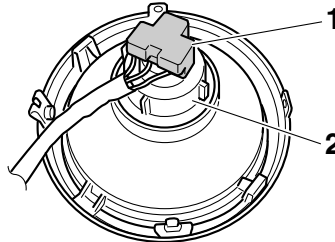

1. Headlight coupler
2. Headlight bulb cover

3. Unhook the headlight bulb holder, and then remove the burnt-out

bulb.

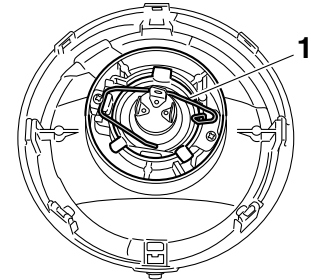

1. Headlight bulb holder

4. Place a new headlight bulb into position, and then secure it with the bulb holder.
5. Install the bulb cover, and then connect the coupler.
6. Install the headlight unit by installing the screws.
7. Have a Yamaha dealer adjust the headlight beam if necessary.

PERIODIC MAINTENANCE AND ADJUSTMENT

EAU24133

Replacing the tail/brake light bulb

1. Remove the tail/brake light lens by removing the screws.

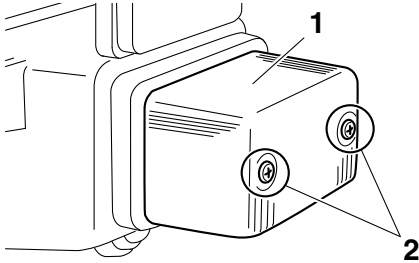

1. Tail/brake light lens
2. Screw

2. Remove the burnt-out bulb by pushing it in and turning it counter-clockwise.

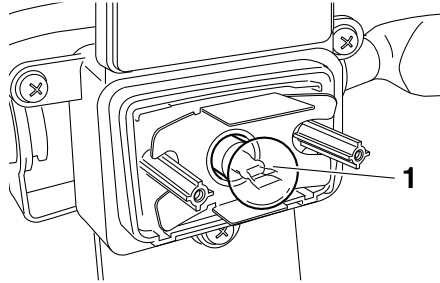

1. Tail/brake light bulb

3. Insert a new bulb into the socket, push it in, and then turn it clockwise until it stops.
4. Install the lens by installing the screws. **NOTICE: Do not over-tighten the screws, otherwise the lens may break.** [ECA10681]

EAU24204

Replacing a turn signal light bulb

1. Remove the turn signal light lens by removing the screw.

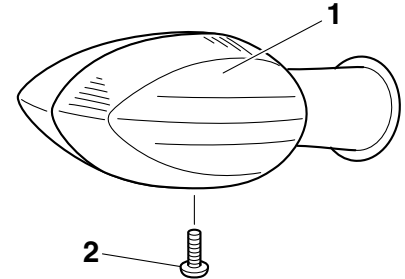

1. Turn signal light lens
2. Screw

2. Remove the burnt-out bulb by pushing it in and turning it counter-clockwise.

PERIODIC MAINTENANCE AND ADJUSTMENT

EAU50573

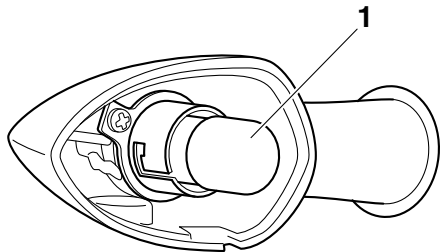

1. Turn signal light bulb

3. Insert a new bulb into the socket, push it in, and then turn it clockwise until it stops.
4. Install the lens by installing the screw. **NOTICE: Do not over-tighten the screw, otherwise the lens may break.**[ECA11191]

Checking the charging cord and charging plug

- Check that there is no damage to the charging cord or charging plug, and if problem is detected, have a Yamaha dealer check the vehicle.
- Check that there is no dirt or foreign material on the charging cord or charging plug. Wipe off any dirt with a dry cloth.

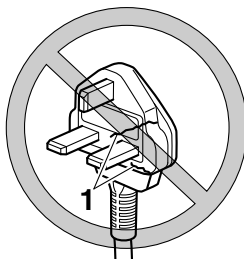

1. Tear

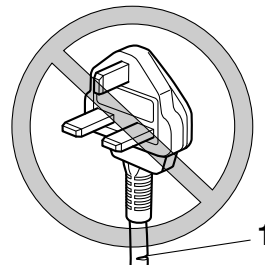

1. Crack

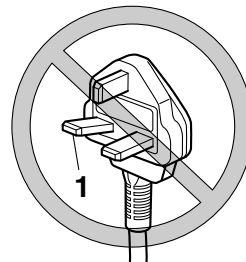

1. Bend

WARNING

- Do not check or repair the vehicle with the charging plug plugged in to the outlet. This could cause an electric shock or short circuit.

EWA15791

PERIODIC MAINTENANCE AND ADJUSTMENT

- **Replace the charging cord or charging plug if damaged. Otherwise, this could cause a fire, electric shock or short circuit.**

ECA17102

NOTICE

Make sure that corrosion inhibitors, solvents or oil do not come in contact with the charging cord or charging plug while checking the vehicle.

Troubleshooting

If a problem occurs, check the following before taking the vehicle to a Yamaha dealer. However, if no electric power is supplied (nothing appears in the display), have a Yamaha dealer check the vehicle.

The vehicle does not enter the standby mode when the key is turned to “ON”

Check the following:

1. Is the vehicle currently being charged?

The vehicle does not enter the standby mode when the key is turned to “ON” during charging.

2. Was the key turned to “ON” while the accelerator grip was being opened?

If the key is turned to “ON” while the accelerator grip is opened, the vehicle does not enter the standby mode. Close the accelerator grip, turn the key to “OFF” and then back to “ON”.

If the vehicle still fails to enter the standby mode, have a Yamaha dealer check

EAU54090

the vehicle.

The vehicle does not start off

Is the vehicle in the riding mode? (Does the operating status indicator “RUN” appear in the display?)

The vehicle cannot be ridden unless it is in the riding mode.

After checking the above, try starting off again by following the procedures described on page 7-1 “Preparations for starting off” and page 7-3 “Starting off” to restart the vehicle.

If the vehicle still does not start off, have a Yamaha dealer check it.

The warning mark “ Turn the key to “OFF” and then back to “ON”. If the warning mark “TIP****

Although the warning mark appears, the vehicle can still be ridden if the operating status indicator “RUN” appears and the vehicle is in the riding mode.

PERIODIC MAINTENANCE AND ADJUSTMENT

A light does not come on

Check the following:

1. Is the vehicle currently being charged? Lights do not come on if the vehicle is being charged.
2. Is the key turned to "ON"? (Does anything appear in the display?)

If nothing appears in the display, the auto-off function may be activated. Turn the key to "OFF" and then back to "ON".

3. Are all switches working properly?

After checking the above, and a light does still not come on, proceed with the following.

- If the headlight fails to come on, the bulb may be burned out. Refer to page 8-12 for replacement procedures.
- If a tail/brake light or turn signal light fails to come on, a bulb may be burned out. Refer to page 8-14 or 8-14 for replacement procedures.

If a light still does not come on, a fuse may be blown. Have a Yamaha dealer check the vehicle.

ECA11982

NOTICE

Do not use a bulb of a wattage other than specified to avoid causing extensive damage to the electrical system and possibly a fire.

The motor stops while riding

Check the following:

1. Is the battery sufficiently charged?
Check the battery level indicator. If the remaining charge is insufficient, charge the battery before continuing to ride.
2. Is "HEAT" flashing and did "RUN" go off?

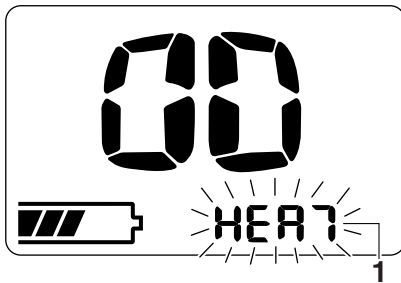

1. Temperature indicator "HEAT"

The temperature protection func-

tion has been activated. Turn the key to "OFF", and allow the vehicle to cool down before continuing to ride.

After checking the above, if the motor still does not run, have a Yamaha dealer check the vehicle.

EWA15631

! WARNING

Before pushing or moving the EC-03, be sure to turn the key to "OFF". The vehicle may suddenly start to move if the accelerator grip is turned while the key is turned to "ON".

The display and headlight go off when the key is turned to "ON"

Check the following:

1. Has the vehicle been stopped for more than five minutes?
To protect the battery, the EC-03 is equipped with an auto-off function. If the vehicle has been stopped for more than five minutes, the power is cut to save the battery charge.
2. Is the battery sufficiently charged?
If the remaining charge is insuffi-

PERIODIC MAINTENANCE AND ADJUSTMENT

cient, charge the battery before continuing to ride.

After checking the above, turn the key to “ON” again. If the display and headlight do not come on, have a Yamaha dealer check the vehicle.

EWA15631

WARNING

Before pushing or moving the EC-03, be sure to turn the key to “OFF”. The vehicle may suddenly start to move if the accelerator grip is turned while the key is turned to “ON”.

The security lock cannot be unlocked

If an incorrect security number is entered three times in succession, the security lock cannot be unlocked even if the correct security number is entered after that.

Turn the key to “OFF” and then back to “ON”, then try entering the correct security number again.

The warning light comes on, and “CHG” and the warning mark “” flash during charging

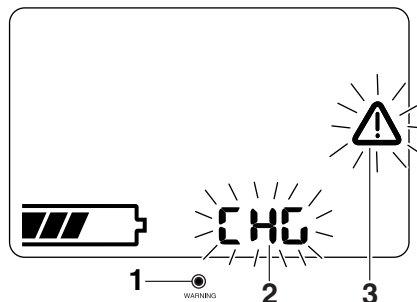

1. Warning light
2. Battery condition indicator “CHG”
3. Warning mark “”

If a problem occurs during charging, the charging automatically stops. The warning light comes on and both “CHG” and the warning mark “” flash.

TIP

If this continues for five minutes, the warning light goes off, along with all indicators in the display.

Unplug the charging plug from the outlet to stop charging, and then start charging again after waiting a few min-

utes. If charging automatically stops again, there may be a malfunction with the vehicle. Stop charging and have a Yamaha dealer check the vehicle.

When the key is turned to “ON”, the warning light comes on and both “CHG” and the warning mark “” flash in the display

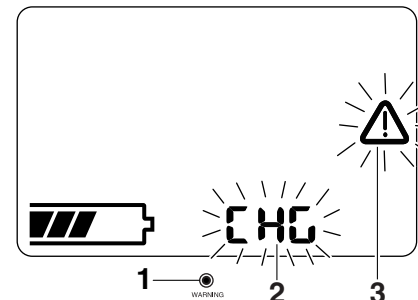

1. Warning light
2. Battery condition indicator “CHG”
3. Warning mark “”

The battery is not charged properly. Turn the key “OFF” and then back to “ON” in order to reset charging. Turn the key to “OFF” and then charge the battery again. After charging, if the above still occurs,

PERIODIC MAINTENANCE AND ADJUSTMENT

there may be a malfunction with the vehicle. Have a Yamaha dealer check the vehicle.

“-----” flashes in the display during charging

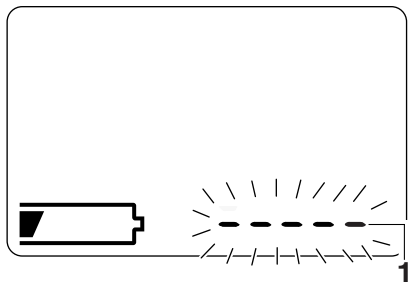

1. Charging error indicator “-----”

If the battery voltage is below the specified level, the display shows this indicator. Continue charging.

If the warning light comes on and both “CHG” and “⚠” flash in the display after charging for one hour, there may be a malfunction with the vehicle. Have a Yamaha dealer check the vehicle.

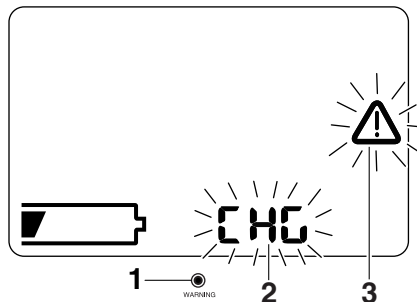

1. Warning light
2. Battery condition indicator “CHG”
3. Warning mark “⚠”

“HEAT” flashes in the display during charging

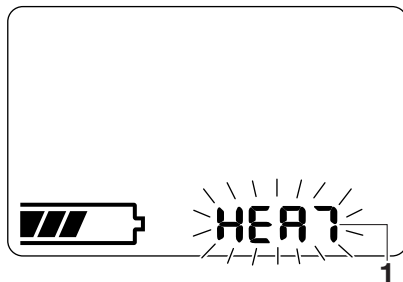

1. Temperature indicator “HEAT”

This is not a malfunction.

The charging process is in the standby mode because the battery temperature is higher than 50 °C. Allow the battery to cool down.

When the battery temperature falls to the specified temperature, “HEAT” goes off and charging starts automatically. (See page 6-1 for more information about “Battery charging place”).

“COOL” flashes in the display during charging

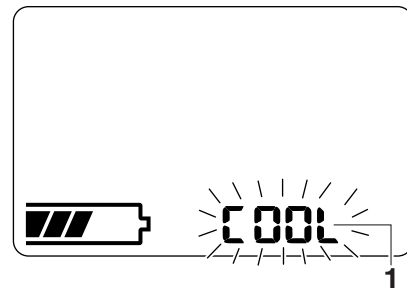

1. Temperature indicator “COOL”

This is not a malfunction.

The charging process is in the standby mode because the battery temperature is lower than -5 °C.

PERIODIC MAINTENANCE AND ADJUSTMENT

If this occurs, start recharging in a warm place.

When the battery temperature reaches the specified temperature, “COOL” goes off and charging starts automatically. (See page 6-1 for more information about “Battery charging place”.)

When the key is turned to “ON”, the beeper sounds and the following occurs

- The warning light flashes
- The warning mark “

1. Battery level indicator
2. Warning light
3. Battery condition indicator “PUSH”/“OLD”
4. Warning mark “

The battery is near the end of its service life.

Push one of the control buttons (See page 4-2.) to cancel the beeper. This switches the vehicle to the standby mode.

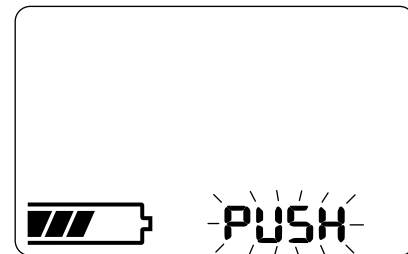

Cancel the standby mode by pushing a control button again.

Although the vehicle can still be ridden if the operating status indicator “RUN” appears, the battery is near the end of its service life. Consult a Yamaha dealer as soon as possible to order a replacement battery.

TIP

If a control button is pushed, the beeper stops and the display changes to the standby mode. If no control button is pushed within five minutes, the auto-off function is activated, and all power is cut to protect the battery.

PERIODIC MAINTENANCE AND ADJUSTMENT

When charging is started, the beeper sounds, and the following indicates the battery is at the end of its service life

- The warning light flashes
- The warning mark “⚠” comes on
- The “PUSH” indicator and “OLD” indicator alternately appear in the display

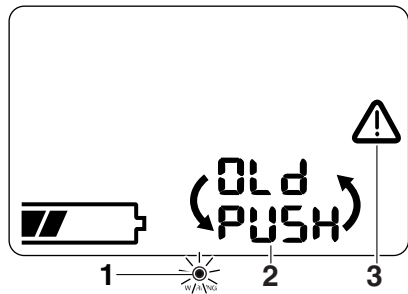

1. Warning light
2. Battery condition indicator “PUSH”/“OLD”
3. Warning mark “⚠”

The battery has reached the end of its service life.

Have a Yamaha dealer replace the battery. Push one of the control buttons (See page 4-2.) to cancel the beeper. This display switches to the following

indicating the battery has reached the end of its service life.

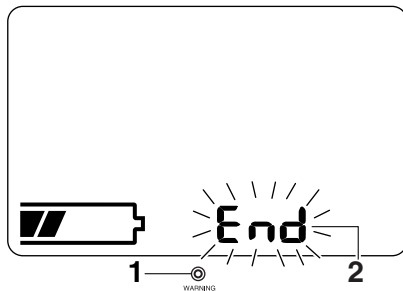

1. Warning light
2. End of battery service life indicator “End”

Unplug the charging plug, and all indicators in the display go off.

TIP

- The beeper continues to sound and “End” is displayed to indicate the end of the battery service life until one of the buttons are pushed.
- To protect the battery, the EC-03 is equipped with an auto-off function. After five minutes have passed, the power goes off, the beeper stops and the display goes off.

The battery cannot be charged (the battery level indicator remains low after charging)

Is the charging plug properly plugged into an outlet?

After checking, charge the battery again by the procedures described in “Charging procedure” on page 6-3.

If the battery still cannot be charged after checking the above, there could be a malfunction in the battery charger. Have a Yamaha dealer check the vehicle.

Unusual odor or smoke emerges from the battery charger

Unplug the charging plug from the outlet immediately. Have a Yamaha dealer check the vehicle.

The riding distance of a single charge has become significantly shorter

The battery has reached the end of its service life.

Have a Yamaha dealer replace the battery.

PERIODIC MAINTENANCE AND ADJUSTMENT

The battery cannot be charged because the residual-current device (RCD) protection has been activated

Stop charging and have a Yamaha dealer check the vehicle.

The battery cannot be charged because the fuse included the charging plug was blown

Stop charging and have a Yamaha dealer check the vehicle.

SCOOTER CARE AND STORAGE

Matte color caution

EAU37833

NOTICE

Some models are equipped with matte colored finished parts. Be sure to consult a Yamaha dealer for advice on what products to use before cleaning the vehicle. Using a brush, harsh chemical products or cleaning compounds when cleaning these parts will scratch or damage their surface. Wax also should not be applied to any matte colored finished parts.

ECA15192

Care

While the open design of a scooter reveals the attractiveness of the technology, it also makes it more vulnerable. Rust and corrosion can develop even if high-quality components are used. Frequent and proper care does not only comply with the terms of the warranty, but it will also keep your scooter looking good, extend its life and optimize its performance.

Before cleaning

1. Make sure that the seat is properly closed before cleaning.
2. Make sure that all caps and covers as well as all electrical couplers and connectors, are tightly installed.
3. Remove extremely stubborn dirt, with a degreasing agent and a brush, but never apply such products onto seals, gaskets and wheel axles. Always rinse the dirt and degreaser off with water.

EAU50832

Cleaning

EWA15810

WARNING

- Do not wash the vehicle while charging the battery. This could cause a fire or electric shock.
 - Make sure that the seat is properly closed before washing. If the seat is not properly closed, water could splash on the battery or built-in charger. This could cause an electric shock or short circuit.
 - Do not wash the charging cord and charging plug. Wipe clean with a dry rag.
-

ECA17122

NOTICE

- Avoid using strong acidic wheel cleaners, especially on spoked wheels. If such products are used on hard-to-remove dirt, do not leave the cleaner on the affected area any longer than instructed. Also, thoroughly rinse the area off with water, immediately dry it, and then apply a corrosion protection spray.

SCOOTER CARE AND STORAGE

- Improper cleaning can damage plastic parts such as cowlings, panels, windshields, headlight lenses, meter lenses, etc. Use only a soft, clean cloth or sponge with water to clean plastic. However, if the plastic parts cannot be thoroughly cleaned with water, diluted mild detergent with water may be used. Be sure to rinse off any detergent residue using plenty of water, as it is harmful to plastic parts.
- Do not use any harsh chemical products on plastic parts. Be sure to avoid using cloths or sponges which have been in contact with strong or abrasive cleaning products, solvent or thinner, gasoline, rust removers or inhibitors, brake fluid, anti-freeze or electrolyte.
- Do not use high-pressure washers or steam-jet cleaners since they cause water seepage and deterioration in the following areas: seals (of wheel and swing-arm bearings, fork and brakes), electric components (couplers,

connectors, instruments, accelerator grip, switches and lights), breather hoses and vents.

- For scooters equipped with a windshield: Do not use strong cleaners or hard sponges as they will cause dulling or scratching. Some cleaning compounds for plastic may leave scratches on the windshield. Test the product on a small hidden part of the windshield to make sure that it does not leave any marks. If the windshield is scratched, use a quality plastic polishing compound after washing.

After normal use

Remove dirt with warm water, a mild detergent, and a soft, clean sponge, and then rinse thoroughly with clean water. Use a toothbrush or bottlebrush for hard-to-reach areas. Stubborn dirt and insects will come off more easily if the area is covered with a wet cloth for a few minutes before cleaning.

After riding in the rain, near the sea or on salt-sprayed roads

Since sea salt or salt sprayed on the roads during winter are extremely corrosive in combination with water, carry out the following steps after each ride in the rain, near the sea or on salt-sprayed roads.

TIP

Salt sprayed on roads in the winter may remain well into spring.

1. Clean the scooter with cold water and a mild detergent after the motor has cooled down. **NOTICE: Do not use warm water since it increases the corrosive action of the salt.**^[ECA10791]
2. Apply a corrosion protection spray on all metal, including chrome- and nickel-plated, surfaces to prevent corrosion.

After cleaning

1. Dry the scooter with a chamois or an absorbing cloth.
2. Use a chrome polish to shine chrome, aluminum and stainless-steel parts.

SCOOTER CARE AND STORAGE

3. To prevent corrosion, it is recommended to apply a corrosion protection spray on all metal, including chrome- and nickel-plated, surfaces.
4. Use spray oil as a universal cleaner to remove any remaining dirt.
5. Touch up minor paint damage caused by stones, etc.
6. Wax all painted surfaces.
7. Let the scooter dry completely before storing or covering it.

EWA15820

WARNING

Contaminants on the brakes or tires can cause loss of control.

- **Make sure that there is no oil or wax on the brakes or tires. If necessary, wash the tires with warm water and a mild detergent.**
- **Before operating the scooter, test its braking performance and cornering behavior.**

ECA10800

NOTICE

- **Apply spray oil and wax sparingly and make sure to wipe off**

any excess.

- **Never apply oil or wax to any rubber and plastic parts, but treat them with a suitable care product.**
- **Avoid using abrasive polishing compounds as they will wear away the paint.**

TIP

- Consult a Yamaha dealer for advice on what products to use.
- Washing, rainy weather or humid climates can cause the headlight lens to fog. Turning the headlight on for a short period of time will help remove the moisture from the lens.

EAU50843

Storage

Short-term

Always store your scooter in a cool, dry place and, if necessary, protect it against dust with a porous cover. Be sure the motor is cool before covering the scooter.

ECA17130

NOTICE

- **Storing the scooter in a poorly ventilated room or covering it with a tarp while it is still wet, will allow water and humidity to seep in and cause rust, power unit failure, electric leakage, or short-circuiting.**
- **To prevent corrosion, avoid damp cellars, stables (because of the presence of ammonia) and areas where strong chemicals are stored.**

Long-term

ECA17143

NOTICE

- **Charge the battery if the level drops to the last segment. In or-**

der to extend the battery life, it is recommended to charge the battery until the battery level indicator reaches a maximum of 2–3 segments. A lower or higher charge is not recommended.

- **Make sure that the amount of charge remaining in the battery does not fall below 20% (less than the last segment of the battery level indicator). If stored under this condition for a long period of time, the battery can be damaged and may need to be replaced depending on how low the capacity is.**
- **Once the battery is completely depleted, it cannot be recharged.**
- **After long-term storage, be sure to recharge the battery before using the vehicle. (It may take longer to charge than usual.)**

Before storing your scooter for several months:

1. Follow all the instructions in the “Care” section of this chapter.
2. Lubricate all control cables and the

pivoting points of all levers as well as the centerstand.

3. Check and, if necessary, correct the tire air pressure, and then lift the scooter so that both of its wheels are off the ground. Alternatively, turn the wheels a little every month in order to prevent the tires from becoming degraded in one spot.

TIP

Make any necessary repairs before storing the scooter.

SPECIFICATIONS

Dimensions:

Overall length:
1565 mm (61.6 in)
Overall width:
600 mm (23.6 in)
Overall height:
990 mm (39.0 in)
Seat height:
745 mm (29.3 in)
Wheelbase:
1080 mm (42.5 in)
Ground clearance:
110 mm (4.33 in)
Minimum turning radius:
1700 mm (66.9 in)

Weight:

Curb weight:
57 kg (126 lb)

Chassis:

Frame type:
Backbone
Caster angle:
25.00 °
Trail:
75 mm (3.0 in)

Front tire:

Type:
With tube
Size:
60/100-12 36J
Manufacturer/model:
INOUE RUBBER/MB80

Rear tire:

Type:
With tube
Size:
60/100-12 36J
Manufacturer/model:
INOUE RUBBER/MB80

Loading:

Maximum load:
87 kg (192 lb)
* (Total weight of rider, cargo and accessories)

Tire air pressure (measured on cold tires):

Front:
200 kPa (2.00 kgf/cm², 29 psi)
Rear:
250 kPa (2.50 kgf/cm², 36 psi)

Front wheel:

Rim size:
12 x 1.50

Rear wheel:

Rim size:
12 x 1.50

Front brake:

Type:
Drum brake
Operation:
Right hand operation

Rear brake:

Type:
Drum brake
Operation:
Left hand operation

Front suspension:

Type:
Telescopic fork
Spring/shock absorber type:
Coil spring
Wheel travel:
50.0 mm (1.97 in)

Rear suspension:

Type:
Unit swing
Spring/shock absorber type:
Coil spring/oil damper
Wheel travel:
55.0 mm (2.17 in)

Headlight:

Bulb type:
Halogen bulb

Bulb voltage, wattage × quantity:

Headlight:
12 V, 35.0 W/35.0 W × 1
Tail/brake light:
12 V, 5.0 W/21.0 W × 1
Front turn signal light:
12 V, 10.0 W × 2
Rear turn signal light:
12 V, 10.0 W × 2
Warning indicator light:
LED

EAU48612

Identification numbers

Record the vehicle identification number and model label information in the spaces provided below for assistance when ordering spare parts from a Yamaha dealer or for reference in case the vehicle is stolen.

VEHICLE IDENTIFICATION NUMBER:

MODEL LABEL INFORMATION:

EAU26400

Vehicle identification number

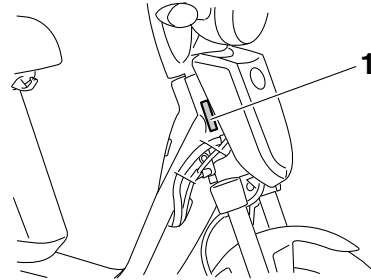

1. Vehicle identification number

The vehicle identification number is stamped into the steering head pipe. Record this number in the space provided.

TIP _____

The vehicle identification number is used to identify your motorcycle and may be used to register your motorcycle with the licensing authority in your area.

EAU26540

Model label

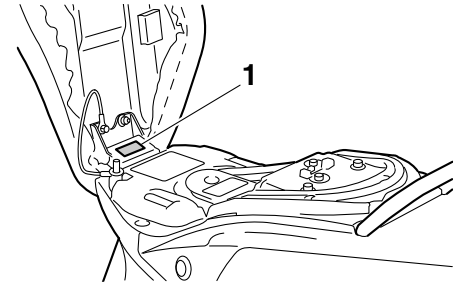

1. Model label

The model label is affixed to the frame under the seat. (See page 4-12.) Record the information on this label in the space provided. This information will be needed when ordering spare parts from a Yamaha dealer.

INDEX

- A**
 - Acceleration and deceleration.....7-4
 - Accelerator grip, checking.....8-5
- B**
 - Battery, charging location6-1
 - Battery, charging procedure.....6-3
 - Battery, charging safely1-5
 - Battery, charging time6-8
 - Battery, effective use of3-3
 - Battery level3-4
 - Battery type, about.....6-9
 - Beeper4-1
 - Brake lever, front.....4-11
 - Brake lever, rear4-12
 - Brake levers, lubricating.....8-10
 - Brake shoes, checking.....8-9
 - Braking.....7-5
- C**
 - Cables, checking and lubricating8-10
 - Care9-1
 - Centerstand, checking and lubricating.....8-11
 - Charging cord and plug, checking8-15
 - Charging display, progress status.....6-9
- F**
 - Features.....3-1
 - Front and rear brake lever free play, adjusting8-8
 - Front fork, checking8-11
- G**
 - Grab bar.....4-14
- H**
 - Handlebar switches.....4-11
 - Headlight bulb, replacing8-12
 - Helmet holder.....4-13
- Horn switch.....4-11
- I**
 - Identification numbers11-1
- L**
 - Luggage hook.....4-13
- M**
 - Main switch/steering lock.....4-1
 - Maintenance and lubrication, periodic8-2
 - Matte color, caution9-1
 - Model label11-1
 - Motor, checking for irregular sounds8-5
 - Multi-function display4-2
- P**
 - Parking7-5
 - Part locations.....2-1
- S**
 - Safe-riding points.....1-5
 - Safety information.....1-1
 - Seat4-12
 - Security lock, using.....4-7
 - Specifications10-1
 - Standard mode/power mode3-1
 - Starting off7-3
 - Starting off, preparations7-1
 - Steering, checking8-12
 - Storage9-3
- T**
 - Tail/brake light bulb, replacing.....8-14
 - Tires.....8-6
 - Traveling distance3-2
 - Troubleshooting.....8-16
 - Turn signal light bulb, replacing.....8-14
 - Turn signal switch.....4-11
- V**
 - Vehicle identification number11-1
- W**
 - Wheel bearings, checking8-12
 - Wheels8-7



PRINTED ON RECYCLED PAPER

PRINTED IN JAPAN
2012.06-0.1×1 
(E)